



AN ISO 9001:2015 & ISO 14001:2015
CERTIFIED COMPANY

www.kptpipes.com



Certified to
NSF/ANSI 61



15801:2008



AN ECO-FRIENDLY & 100% FOOD GRADE PPR-PLUMBING SYSTEM WITH THE BEST IN CLASS APPLICATIONS FOR INDUSTRIAL & COMMERCIAL SEGMENT FOR HOT & COLD WATER APPLICATIONS

Pioneers in India to have PPR-C Range from **16mm to 400mm**

Manufacturers and Exporters of Commercial & Industrial PPR Pipes & Fittings





**ONE OF THE
FINEST & BIGGEST RANGE
OF
COMMERCIAL & INDUSTRIAL
PPR PIPES & FITTINGS
UNDER ONE ROOF**

**MONO AND TRIPLE LAYER
GREEN, BLUE, WHITE
GREY & RED COLOUR**

green therm

pneumato
PNEUMATIC PIPES

thermaplus
Thermal FR Composite Piping



Technical Information Polypropylene Random Copolymer

Why choose this type of material?

The thermoplastic resins most often used to make pipes for water and heating systems are:

- PE-X cross linked polyethylene
- PP-C copolymer polypropylene
- PB polibutene

All the above - mentioned resins belong to the polyolephine family, a group of plastic materials obtained by polymerization of unsaturated hydrocarbons, which have one or more double links.

In a conventional polymer the molecular chains are irregularly placed; they have fairly good mobility, heat causes oscillation in these chains until they break, resulting in alteration of the material's characteristics. Two ways of preventing this problem have been tested.

Researchers have selected polymers with long molecular chains because, as molecular weight increases, the mechanical characteristics of manufactured items improve; these chains must be as linear as possible, i.e. they must show a low number of ramifications and a high degree of crystallization by extrusion these chains are submitted to stretch, allowing crystallization of a further percentage.

Isotactic polymers show much better mechanical characteristics as compared to their correspondent amorphous polymers; they maintain their properties up to temperatures close to melting point. This describes the nature of polypropylene techno- polymers in a simple way.

The other way tested by researchers is creation of chemical links among molecular chains in order to make them much steadier and avoid their sliding. This procedure has been adopted for the cross linking of polyethylene-PE- X.

There is a very big production of PP copolymers it is therefore important that fitness of raw material used be proven; it must be suitable to bear the thermo mechanical stresses required of it in operation for a long time (50 years).

Thus it is guaranteed that goods manufactured have high mechanical properties; it has been stabilized with appropriate anti-oxidants to postpone the combined effects of pressure and temperature for a very long time.

PROPERTY OF RAW MATERIAL

KPT- PPR Plumbing Pipe system is made from Basel & Hyosung materials which are considered as one of the best PPR-C material all over the world, a Random Copolymer Polypropylene (PPR-C) approved for the production of pipes and fittings according to DIN 8078 & DIN 16962 standards. Hyosung PPR Raw material is a thermoplastic resin which is transformed in to the finished product by a rise in temperature, which plasticises the material, allowing the pipe to be produced by means of EXTRUSION, and the fittings by MOULDING. The raw material is supplied in granules precolored. Special heat resistance is one of the features of this material, Its physical and chemical properties are well suited to the transfer of potable water and in the heating sector. Depending on pressure it is possible to use KPT - pipes for constant temperatures up to 70°C with service life of more than 50 years. Peak temperatures of 100°C arising from short disruptions are not creating any problems.

Advantages of KPT PPR-C Piping System

KPT pipes and fittings are made from polypropylene random copolymer specially developed for this use. Its characteristic make it suitable for both Industrial and Commercial applications with outstanding reliability over time.

One special feature of the KPT PPR-C pipe system is the assembly technique, in which the parts to be connected are welded by melting and fusion. After fusion welding, the pipe and fittings form a single continuous body with none of the problems, which may derive from potential leakage points. This makes the joints as PERMANENT. No sealants or adhesives are required for these permanent connections.

Special Features of KPT PPR-C Piping System

Anti Corrosive & Chemical Resistant - Chemically inert and highly resistant to wide range of acid bases. Suitable for highly corrosive areas and industrial cooling water, drinking water system.

Withstanding High Pressure - Pipes and fittings can withstand up to 20 kg/sqcm pressure. Suitable for high pressure application like Compressed Air Lines.

Low Pressure Drop - Because of the very smooth non porous inner surface of pipes and fittings the pressure loss is less than metallic pipes, which results saving of pumping energy considerably.

Withstanding Higher Temperature - Can withstand upto 95°C. Best pipe for heated water transport in solar applications.

Hygienic & Harmlessness - KPT PPR-C pipes are certified as food grade pipes as per DIN 1998 T2. Best piping system for drinking water, RO plants and DM Plants.

Low Thermal Conductivity - The material's high level of thermal insulation guarantees low heat loss on the part of fluid transport. (0.24 W/mK)

Low Noise - Having high sound insulation value, results in lower noise level at the time of high velocity flow.

Non Toxic - Recyclable - Unlike PVC pipes, KPT PPR-C pipes are non toxic at the time of fire. PPR-C is recyclable material.

High Impact Rate - KPT PPR-C pipes are having high impact strength compare to any plastic pipe.

Low Flammability - KPT PPR-C pipes and fittings comply with fire classification B2 (normal inflammable). In case of fire no toxic emission to atmosphere like PVC pipes.

Resistant to stray electrical current - Thanks to high electrical insulating properties, KPT PPR-C pipe system is unaffected by stray currents

Like SS Pipe - The characters of KPT PPR-C piping system is almost like SS. KPT PPR-C pipes will have more advantage than SS for the specific application requirements.

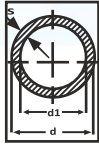

**KPT PPR-C Pipe
SDR 11/ S 5/ PN 10**

Pipe	Diameter	Wall Thickness	Internal Diameter	Water Content	
Dimension	Packing Unit	d(mm)	S(mm)	di(mm)	litre/mtr
20mm	240m	20	1.9	16.2	0.206
25mm	180m	25	2.3	20.4	0.327
32mm	120m	32	2.9	26.2	0.539
40mm	75m	40	3.7	32.6	0.834
50mm	45m	50	4.6	40.8	1.307
63mm	30m	63	5.8	51.4	2.074
75mm	21m	75	6.8	61.4	2.959
90mm	15m	90	8.2	73.6	4.252
110mm	12m	110	10.0	90.0	6.359
125mm	9m	125	11.4	102.2	8.199
160mm	6m	160	14.6	130.8	13.430
200mm	3m	200	18.2	163.6	21.010
250mm	3m	250	22.7	204.6	32.861
315mm	3m	315	28.6	257.8	52.172
355mm	3m	355	32.2	290.6	66.292
400mm	3m	400	36.3	327.4	84.145

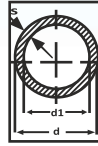

**KPT PPR-C Pipe
SDR 7.4/ S 3.2/ PN 16**

Pipe	Diameter	Wall Thickness	Internal Diameter	Water Content	
Dimension	Packing Unit	d(mm)	S(mm)	di(mm)	litre/mtr
16mm	300m	16	2.2	11.6	0.106
20mm	240m	20	2.8	14.4	0.163
25mm	180m	25	3.5	18.0	0.254
32mm	120m	32	4.4	23.2	0.423
40mm	75m	40	5.5	29.0	0.660
50mm	45m	50	6.9	36.2	1.029
63mm	30m	63	8.6	45.8	1.647
75mm	21m	75	10.3	54.4	2.323
90mm	15m	90	12.3	65.4	3.358
110mm	9m	110	15.1	79.8	4.999
125mm	9m	125	17.1	90.8	6.472
160mm	6m	160	21.9	116.2	10.599
200mm	3m	200	27.4	145.2	16.550
250mm	3m	250	34.2	181.6	25.888
315mm	3m	315	43.4	228.2	40.879
355mm	3m	355	49.0	257	51.848

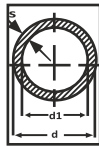

**KPT PPR-C Pipe
SDR 6/ S 2.5/ PN 20**

Pipe	Diameter	Wall Thickness	Internal Diameter	Water Content	
Dimension	Packing Unit	d(mm)	S(mm)	di(mm)	litre/mtr
16mm	240m	16	2.7	10.6	0.088
20mm	210m	20	3.4	13.2	0.137
25mm	150m	25	4.2	16.6	0.216
32mm	105m	32	5.4	21.2	0.353
40mm	60m	40	6.7	26.6	0.555
50mm	36m	50	8.3	33.4	0.876
63mm	24m	63	10.5	42.0	1.385
75mm	21m	75	12.5	50.0	1.963
90mm	12m	90	15.0	60.0	2.826
110mm	9m	110	18.3	73.4	4.229
125mm	6m	125	20.8	83.4	5.460
160mm	3m	160	26.6	106.8	8.954

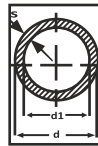

**KPT PPR-C Pipe
SDR 17.6/ S 8.3/ PN 6**

Pipe	Diameter	Wall Thickness	Internal Diameter	Water Content	
Dimension	Packing Unit	d(mm)	S(mm)	di(mm)	litre/mtr
63mm	30m	63	3.6	55.8	2.444
75mm	21m	75	4.3	66.4	3.461
90mm	15m	90	5.1	79.8	4.999
110mm	12m	110	6.3	97.4	7.447
125mm	9m	125	7.1	110.8	9.637
160mm	6m	160	9.1	141.8	15.784
200mm	3m	200	11.4	177.2	24.649
250mm	3m	250	14.2	221.6	38.549
315mm	3m	315	17.9	279.2	61.193
355mm	3m	355	20.1	314.8	77.793
400mm	3m	400	22.7	354.6	98.707

PERMISSIBLE WORKING PRESSURE

The below table list is the allowable working pressure for pipes with different pressure class under specific temperature and work life. Under normal work pressure and conditions, the life of KPT PPR Piping system is guaranteed to be 50 years at least.

Temperature in C	Years of Service	Allowable working pressure, in bar for			
		PN-6 (SDR 17.6)	PN-10 (SDR 11)	PN-16 (SDR 7.4)	PN-20 (SDR 6)
10°C	1	10.6	17.6	27.8	35.0
	5	10.0	16.6	26.4	33.2
	10	9.7	16.1	25.5	32.1
	25	9.4	15.6	24.7	31.1
	50	9.1	15.2	24.0	30.3
100	8.9	14.8	23.4	29.5	
20°C	1	9.0	15.0	23.8	30.0
	5	8.5	14.1	22.3	28.1
	10	8.2	13.7	21.7	27.3
	25	8.0	13.3	21.1	26.5
	50	7.8	12.9	20.4	25.7
100	7.5	12.5	19.8	24.9	
30°C	1	7.7	12.8	20.2	25.5
	5	7.2	12.0	19.0	23.9
	10	7.0	11.6	18.3	23.1
	25	6.7	11.2	17.7	22.3
	50	6.6	10.9	17.3	21.8
100	6.4	10.6	16.9	21.2	
40°C	1	6.5	10.8	17.1	21.5
	5	6.1	10.1	16.0	20.2
	10	5.9	9.8	15.6	19.6
	25	5.7	9.4	15.0	18.8
	50	5.5	9.2	14.5	18.3
100	5.4	8.9	14.1	17.8	

Temperature in C	Years of Service	Allowable working pressure, in bar for			
		PN-6 (SDR 17.6)	PN-10 (SDR 11)	PN-16 (SDR 7.4)	PN-20 (SDR 6)
50°C	1	5.5	9.1	14.4	18.2
	5	5.1	8.5	13.5	17.0
	10	5.0	8.2	13.1	16.5
	25	4.8	8.0	12.6	15.9
	50	4.6	7.7	12.2	15.4
100	4.5	7.4	11.8	14.9	
60°C	1	4.6	7.6	12.1	15.5
	5	4.3	7.2	11.4	14.3
	10	4.2	6.9	11.0	13.8
	25	4.0	6.7	10.5	13.3
	50	3.8	6.4	10.1	12.7
70°C	1	3.9	6.5	10.3	13.0
	5	3.6	6.0	9.5	11.9
	10	3.5	5.9	9.3	11.7
	25	3.0	5.1	8.0	10.1
	50	2.6	4.3	6.7	8.5
80°C	1	3.3	5.5	8.6	10.9
	5	2.9	4.8	7.6	9.6
	10	2.4	4.0	6.3	8.0
	25	1.9	3.2	5.1	6.4
	50	1.5	2.5	4.0	5.0
95°C	1	2.3	3.9	6.1	7.7
	5	1.5	2.5	4.0	5.0
	(10)'	(1.3)'	(2.1)'	(3.4)'	(4.2)'

RESISTANCE TO CHEMICALS

Polypropylene has high resistance to a large number of aggressive substances, and is therefore particularly suitable for special applications. The table below provides resistance of Polypropylene to various chemicals. For transport of combustible fluids, please comply with any legal regulations in force. Take care when the installation is to carry water with chlorine content over the limits permitted by law and/or contains elements which induce oxidation in general.

Symbols	+	highly resistant	0	fairly resistant	-	not resistant	T	all%
	(+)	resistant	(-)	scarcely resistant	sol.sat.	saturated solution	s	it loses colour

Examined substances %	Concentration 20 60 100	Temperature(°C)		
		20	60	100
Acetone	100	+	0	
Acid (see acid name)				
Acetic acid	100	+	+	
Acetic anhydride	100	+		
Alum	sol. sat	+	+	
Aluminium salt	T	+	+	+
Amber acid	sol. sat.	+	+	
Ammonia gas	100	+	+	
Ammonia (liquid)	conc.	+	+	
Ammonia acetate	T	+	+	+
Ammonium nitrate	T	+	+	+
Ammonium phosphate	T	+	+	+
Ammonium sulphate	T	+	+	+
Aniline	100	+	(+)	
Antifreeze		+	+	
Apple juice		+	+	
Asphalt		+	0	
Aspirin		+		
Barium Chloride	T	+	+	+
Battery Acid		+	+	
Beer		+		
Benzaldehyde	100	+		
Benzaldehyde(liquid)	sol.sat.(0.3)	+		
Benzoid acid	100	+	+	
Benzol	100	(-)	-	
Benzoyl chloride	100	(-)	-	
Borax	sol. sat.	+	+	
Boric acid	100	+	+	
Bromine(liquid)	100	-		
Bromine dry steam	high conc.	-	-	
Bromine dry steam	low conc.	0	-	
Butane liquid	100	+		
Butane gas	100	(+)	+	
Butter	100	+	+	
Butyl alcohol		+	+	Butyl
Gas	100	(+)	+	
Calcium, chloride	sol. sat.	+	+	+
Calcium, nitrate	sol. sat.	+	+	
Carbon, tetrachloride	100	(-)	-	
Chlorine, liquid	100	-		
Chloride,dry gas	100	-	-	-
Chloride, wet gas	100	0	-	-

Examined substances	Concentration %	Temperature(°C)		
		20	60	100
Chloroform	100	+	0	
Chlorosulfonic, acid	100	-	-	-
Chromic, acid		+	0	
Chromium plating bath		+	+	
Chromium trioxide	sol. sat	+	-	
Coca Cola®		+		
Cocoa		+	+	(+)
Coffee		+	+	+
Copper, salt	sol. sat	+	+	+
Copper, nitrate 30%		+	+	+
Cream		+		
Cresol 100		+	0	
Cyclohexan	100	+		
Cyclohexanol	100	+	+	
Diesel oil		+	0	
Diethyl ether	100	0		
Dimethyl formamide	100	+		
Diossano	100	+	0	-
Dixan liquid		+	+	+
Dry salt		+	+	
Ethyl, acetate	100	0	0	
Ethyl, alcohol	100	+		
Ethyl, bebzol	100	0	-	
Ethyl, chloride	100	-		
Ethyl, hexanol	100	+		
Formaldehyde	40	+	+	
Formic, acid		+		
Fruit juice		+	+	
Gelatine		+	+	(+)
Gin 40		+		
Glycerine	100	+	+	
Glycerine, liquid	low conc.	+	+	+
Glycolic, acid	100	+	+	
Glucose		+	+	+
Heptane	100	(+)	+	
Hexane	100	+	0	
Hydrochloric, acid	high conc.	+	+	
Hydrochloric, acid	low conc.	+	+	
Hydrochloric, ammonium	T	+	+	+
Hydrogendioxide	10	+	+	
Iodine, tincture		+S		
Iron, salt	sol. sat.	+	+	+

Examined substances	Concentration %	Temperature(°C)		
		20	60	100
Iso octane	100	+	0	
Iso propylic alcohol	100	+	+	
Jam		+	+	(+)
Latic acid		+	+	
Lanolin		+	0	
Lemonades		+		
Lemon juice		+	+	
Liquors	T			
Magnesium, salt	sol. sat	+	+	+
Margarine		+	+	
Mayonnaise		+		
Menthol		+		
Mercury	100	+	+	
Methanol	100	+	+	
Methyl chloride	100	0		
Methyl-ethy-ke-ton	100	+	0	
Milch		+	+	(+)
Muriatic, acid	10	+	+	
Mustard		+	+	
Nephtalene, decahydro	100	(-)	-	-
Naphtalene	100	+		
Naphthalene, trachloride	100	0	-	
Nitric, acid	10	(+)	-	-
Nickel, salt	sol. sat.	+	+	
Nitrobenzene	100	(+)	0	
Octane		+	0	
Oil	100	+	0	
Oil ether	100	+	0	
Oil of turpenthine		0		
Oleic, salt	100	+		
Oleum	T	-	-	-
Orange, juice		+	+	
Ozone	<0.5ppm.	(+)	(+)	
Oil:				
Almond oil		+	+	
Animal oil		+	(+)	(-)
Camphor oil		+	+	
Coconut oil		+	(+)	
Cod oil		+		
Cloves oil		+		
Com oil		+	0	
Linseed oil		+	+	
Motor oil		+	0	-
Olive oil		+	+	
Ocalic oil		+	+	+
Paraffin oil		+	0	-
Peppermint oil		+	+	
Rasin oil		+	(+)	
Silicone oil			+	(+)
Paraffin	100	+	+	-
Petroleum	100		+	
Pepper		+	+	
Perborax	sol.sat.(1.4)	+	+	+
Perfume		+		
Henol	sol. sat.	+	+	

Examined substances	Concentration %	Temperature(°C)		
		20	60	100
Phosphorus, acid	sol. sat.	+	0	
Phosphorus, oxichloride	100	0	-	-
Photographic acid		+	+	
Potassium Carbonate	sol. sat.	+	+	
Potassium Chlorate	sol.sat.(7.3)	+	+	
Potassium Chlorate	sol. sat.	+	+	
Potassium Chromate	sol.sat(12)	+	+	+
Potassium iodides	ol.sat.	+	+	
Potassium nitrate	sol. sat.	+	+	
Potassium permangan	sol.sat.(6.4)	+	(+)	
Potassium persulfate	sol.sat.(0.5)	+		
Potassium sulfate	sol. sat.	+	+	+
Propane gas	100	+	+	
Propane, liquid	100	+		
Pyridine	100	+	0	
Quinine		+		
Silver, salt	sol. sat.	+	+	
Soap liquid	10	+	+	+
Soda caustic	100	+	+	
Sodium bicarbonate	sol. sat.	+	+	+
Sodium carbonate	sol.sat.	+	+	
Sodium chlorate	25	+	+	
Sodium chloride	sol. sat.	+	+	+
Sodium hypochlorite	5	+	+	
Sodium nitrate	sol. sat.	+	+	
Sodium phosphate	sol. sat.	+	+	+
Sodium sulphate	sol. sat.	+	+	+
Sodium sulphite	sol. sat.	+	+	
Sodium thiosulphate	sol. sat.	+	+	
Starch	T	+	+	
Sulphure, carbon		0		
Tea		+	+	(+)
Tetra-chlorine-ethylen	100	0	-	
Tetraidrophurano	100	0	-	
Thiophene	100	0	-	
Tin II chloride	sol. sat.	+	+	
Toothpaste		+	+	
Trichlorethylene	100	0	(-)	
Tricresylphosphosphate		+		
Turpentine	100	-		
Urea	sol. sat.	+	+	
Vanilla		+	+	
Vaseline		+	0	
Vinegar		+	+	
Water:				
Boric water	sol. sat. (4.9)	+	+	
Brackish water		+	+	+
Chlorinated water	sol. sat.	0	-	
Distilled water	100	+	+	+
Drinking water		+	+	+
Lake water		+	+	+

STANDARDS	FIELDS
DIN 1998	Drinking water line installation
DIN2999	Whitworth pipe threads for tubes and fitting
DIN 4109	Sound insulation in building constructions
DIN 8077	Polypropylene (pp)pipes dimensions
DIN 8078	Polypropylene (pp)pipes general quality requirements and testing.
DIN 16962	Polypropylene (pp)pipes fitting
DIN 16928	Pipe connections and components-pipes of thermoplastic materials: pipe joints, element for pipe, laying: general directions.
DIN 16928(6-9)	Pipe joints and elements for polypropylene (pp) pressure pipelines, types 1 and 2; injection molded elbows for socket - welding, dimension.
DIN 16925.5	Pipe joins and elements for polypropylene (pp) for pipes under, -part 5; general quality
DIN 2207.11	Welding regulations for plastic pipes.
DVS 2203	Test of thermoplastic pipe fitting for weld
DVS 2208.1	Machines and devices for welding thermoplastic pipes.
EN ISO 1587 4(1-7)	Plastic piping systems for hot cold water installations polyprppylene(pp)
IS 15801 :2008 BIS	BUREAU OF INDIAN STANDARDS
BS 6920	British Standard Suitability of Non-Metallic Products for use in Contact with Water Intended for Human Consumption With Regard To Their Effect on the Quality of the Water.
NSF/ANSI Standard 61	Drinking Water System Components - Health Effects.
CBRI Roorkee	Drinking Water System Components - Health Effects

Testing

KPT is having in house testing facility to do above tests as per the BIS, DIN and NSF Standard for:

- Testing of incoming Raw material.
- Final inspection and dispatch.
- Inspection and testing during production as per standards.
- Periodical calibration of testing equipments

PROPERTIES	PP-R	GI	COPPER	HDPE	CPVC
Service life(years)	50 Years plus	10 Years	10 - 25 Years	20 - 30 Years	20 - 30 Years
Temperature Resistance	Very Good	Excellent	Excellent	Good	Good
Food grade	Excellent, Hygienic	Non - Hygienic	Non - Hygienic	Good	Non - Hygienic
Heat Loss	Negligible	Very High	Very High	Moderate	Moderate
Chemical Resistance	Excellent	Very Weak	Weak	Good	Good
Maximum safe working temp 'c'	99	High	High	80	80
Ease of Repair/maintenance	Easy/Nil	Huge Cost	Huge cost	Easy/Nil	Easy/Nil
Corrosion/ Abrasion Resistance	Excellent	Very low	Very low	Good	Moderate
Friction Factor	Very Low	High	High	Low	Low
Reliability	Very Good	Poor	ok/Expensive	Average	Average
Joint Reliability/Leak proof (Max:100, min:0)	99	80	80	60	70
Joining Method	Heat Fusion	Heat Fusion	Brazing	Butt Fusion	Special Solvent Chemical
Joining Skill	Very simple & can be done by unskilled labour	needs skilled labour	Needs Skilled Labour	Needs Skilled Labour	Needs Special by attention & Skilled Labour
Joining life commissioning	Immediate	24 hours	24 hours	Few Hrs	24 hours
Easiness in fittings	Very Easy	difficult	difficult	Easy	Easy
Laying(Easiest= 100 & Hardest=0)	100	0 - 50	0 - 50	0 - 80	0-80

TESTING EQUIPMENT & QUALITY CONTROL

1 Density	Weighing Balance	6.2.1 & 9.5	IS: 15801/2008 IS:13360(Part 3/section 1 IS: 12235 (Part 14)	This test is carried out to know the density of pipe, specially for green pipe which are used in hot and cold water supply. Density should be 900 to 910 kg/m ³
2 M.F.R	M.F.I Machine	6.2.2	IS: 15801/2008 IS:13360 (Part 4 section 1)	This test is carried out to know the melt ow rate of Material used in manufacturing of pipe. M.F.R Value should be Less or equal to 0.5 GM /1 0 Minutes
3 Visual appearance	Manually	8	IS :15801/2008	This test is carried out to know the Visual appearance of pipe It includes smooth and clean internal and external surface of pipe as well as square cutting of pipe ends
4 Reversion test	Hot air Oven	9.3	IS:15801 /2008 IS :12235 (Part 5/section 1)	This test is carried out to know the longitudinal reversion of pipe . Its value shall not be more then 2%
5 Fusion Compatibility	Hydrostatic Machine & Hot water bath	9.1 & 9.2 TABLE 3 Serial no. (iii)	IS: 15801/2008	This test is carried out to know about fusion strength of pipe and fittings to bear the hydraulic characteristic in accordance 9.1 & TABLE 3 Serial No (iii)
6 Thermal Stability	Hydrostatic Machine & Hot air Oven	9.8	IS 15801 :2008 IS 12235:Part 8/Section (1)	This test is carried out under high temperature and pressure of water or air for 8760 hours . The Outer medium shall not burst during the test period
7 Opacity Tester	Opacity Tester	9.9	IS 15801 :2008 IS 12235 (Part 3)	This test is carried out to know the percentage of visible light transmit through plain surface of pipe . Its value should not more than 2 %
8 Impact test	Charpy Impact Testing machine	9 & Annex b	IS 15801:2008	This test is carried out to know the internal hydrostatic pressure applied by fluid under specific temperature and pressure
9 Hydraulic characteristic (Internal creep rupture)	Hydrostatic Machine	9.1	IS 15801:2008 IS :10910 IS: 9845	This test is carried out to know the internal hydrostatic pressure applied by fluid under specific temperature and pressure
10 Influence Of water For Human consumption	Hot air Oven & Hot Plate	6.6	IS 15801 : 2008	This test is carried out the effect of pipe material on fluid owing inside pipe . It shall not adversely effect the quality of drinking water
11 Outsider Diameter and Ovality	vernier Caliper and pie tape	7.1 & 7.3.2 table 1	IS15801: 2008	This test is carried out to know the specific outside diameter and ovality of pipe as per standard
12 Wall Thickness	Micrometer	7.2 & 7.3.1 Table 2	IS15801: 2008	This test is carried out to know the specific wall thickness of pipe as per standard
13 Length of straight pipe	Measuring tape	7.4	ISI5801:2008	This test is carried out to know the specific length of pipe as per standard

KPT is having in-house testing facility to do above tests as per the BIS, DIN & NSF standard.

Linear expansion of KPT PPR-C Pipes and fittings

Pipe Length L(m)	Temperature Difference DT (°C)									
	10	20	30	40	50	60	70	80	90	95
1.0	1.5	3.0	4.5	6.0	7.5	9.0	10.5	12.0	13.5	14.3
2.0	3.0	6.0	9.0	12.0	15.0	18.0	21.0	24.0	27.0	28.6
3.0	4.5	9.0	13.5	18.0	22.5	27.0	21.5	36.0	40.5	42.9
4.0	6.0	12.0	18.0	24.0	30.0	36.0	42.0	48.0	54.0	57.2
5.0	7.0	15.0	22.5	30.0	37.5	45.0	52.5	60.0	67.5	71.5
6.0	9.0	18.0	27.0	36.0	45.0	54.0	63.0	72.0	81.0	85.8
7.0	10.5	21.0	31.5	42.0	52.5	63.0	73.5	84.0	94.5	100.1
8.0	12.5	24.0	36.0	48.0	60.0	72.0	84.0	96.0	108.0	114.4
9.0	13.5	27.0	40.5	54.0	67.5	81.0	94.5	108.0	121.5	128.7
10.0	15.0	30.0	45.0	60.0	75.0	90.0	105.0	120.0	135.0	143.0

Note: Linear expansion unit in mm.

Support Intervals

Pipe Diameters mm	Temperature								
	0°C	20°C	30°C	40°C	50°C	60°C	70°C	80°C	95°C
16mm	80	60	60	50	50	45	40	30	25
20mm	90	65	65	60	60	55	50	40	35
25mm	110	80	75	70	70	65	60	50	45
32mm	120	95	95	85	80	75	70	60	55
40mm	145	110	110	90	90	85	80	70	60
50mm	170	130	120	110	110	100	95	75	70
63mm	190	150	140	130	120	110	100	90	75
75mm	210	160	150	140	130	120	110	100	85
90mm	220	160	160	150	150	140	125	105	90
110mm	250	180	180	170	170	160	140	125	110
160mm	300	210	210	190	180	170	150	135	120
200mm	330	230	220	200	190	180	160	145	130
250mm	360	260	250	220	200	190	170	155	135
315mm	325	315	305	295	285	270	260	245	205
355mm	345	335	325	315	300	285	275	260	215
400mm	365	355	345	335	320	305	290	275	230

Support Intervals (CM)

KPT PPR-C Characteristics

1. PHYSICAL PROPERTIES

PROPERTY	TEST MOTHED	UNIT	VALUE
Density at 23°C	ISO 1183	Kg/m ³	905
Melt Flow Rate	ISO 1133	gm/10min	0.50
MFR 190°C/5kg		gm/10min	0.35
MFR 230°C/2.16kg		gm/10min	1.50
MFR 230°C/5kg			
Viscosity	ISO 1628 T3	cm ² /g	430

2. THERMAL PROPERTIES

PROPERTY	TEST MOTHED	UNIT	VALUE
Thermal Conductivity	DIN 52612	W/mK	0.24
Specific heat at 20°C	Calorimeter	KJ/KgK	2
Coefficient Linear Thermal Expansion	DMA Method	°C	1.5X10 ⁻⁴
Melting Temperture Rate	DIN 53736	°C	150-154
VICAT Softening Temperture	DMA Method	°C	147.32

3. MECHANICAL PROPERTIES

PROPERTY	TEST MOTHED	UNIT	VALUE
Tensile Stress at Yield (50mm/min.)	ASTMD 638	MPa	27
Tensile Strain at Yield (50mm/min.)	ASTMD 638	%	14
Tensile Modulus		MPa	850
Flexural Modulus	ASTMD 790A	MPa	850
Tear Strength	ISO 527	MPa	40
Elongation at Tear	ISO 527	%	800
Shore D hardness	DIN53505	-	65
Pipe Friction Factor		-	0.007
Charpy Impact Strength, Notched 23°C 0°C -20°C		KJ/m ²	20
			3.5
			2
Charpy Impact Strength, Unnotched 23°C 0°C -20°C		KJ/m ²	No Break
			No Break
			40

4. ELECTRICAL PROPERTIES

PROPERTY	TEST MOTHED	UNIT	VALUE
Die Electric Strength	DIN 53481	Kv/mm	≥20
Die Electric Constant	DIN 53483	-	2.3
Volume Resistivity	DIN 53482	Ohm-cm	>1X10 16

Long Term behaviour of PP-R pipes

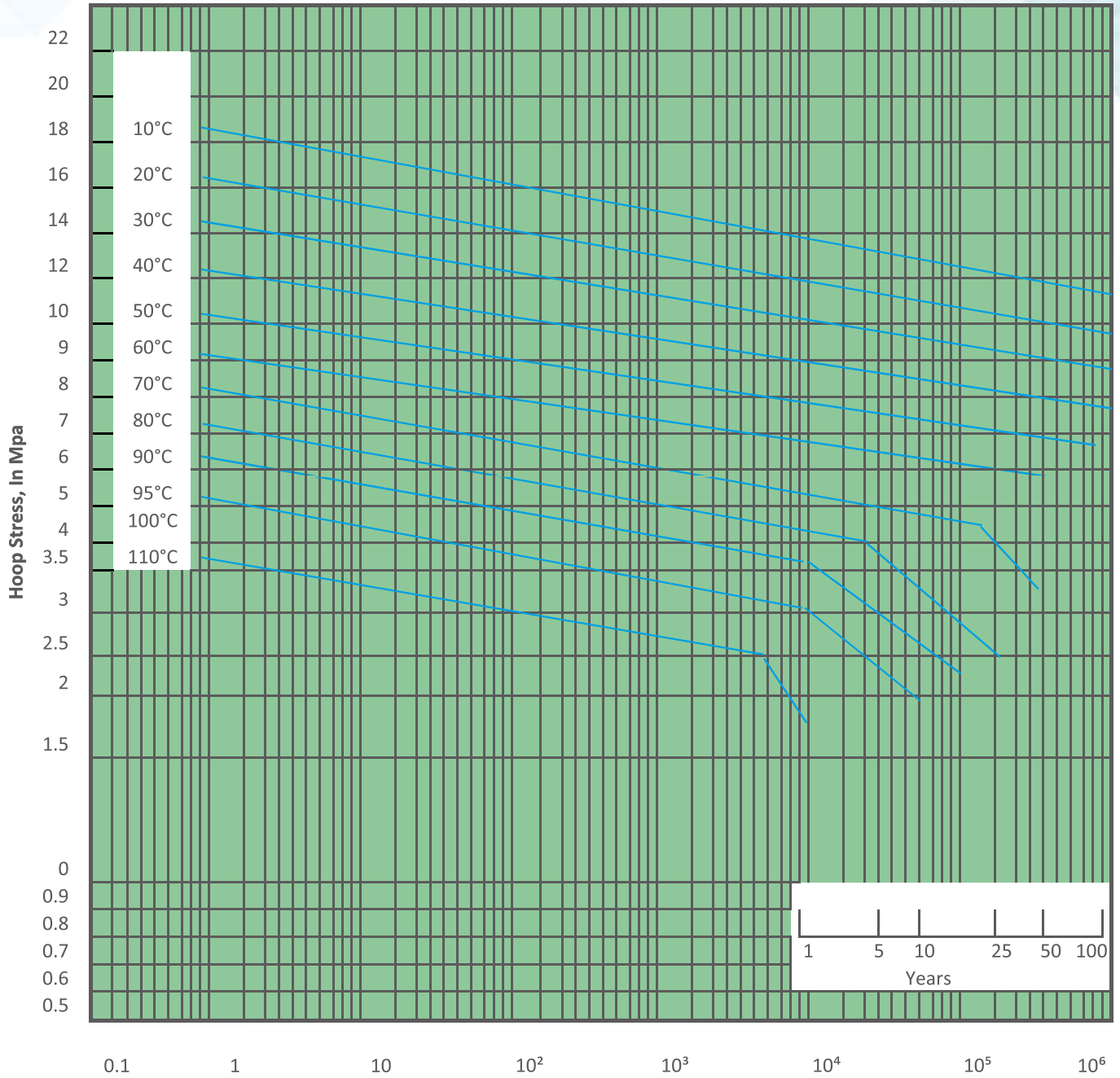

Conversion from inch to mm.

Inch.	MM
1/2"	20
3/4"	25
1"	32
1-1/4"	40
1-1/2"	50
2"	63
2-1/2"	75
3"	90

Inch.	MM
4"	110
6"	160
8"	200
10"	250
12"	315
14"	355
16"	400

FUSION METHOD

The process of joining PPR-C pipes and fittings is very simple and results in inseparable watertight joints. It is carried out using a simple welding machine that fuses the internal surface of the fitting and the external surface of the pipe, so that the material of the pipe and the fitting will be bonded together.

THE FOLLOWING DESCRIBE THE STEPS OF THE WELDING PROCESS

Prepare the welding machine by fitting it with the welding dies of the diameters to be welded. Connect the plug to the 220V power supply socket and wait until the green light on the machine goes out indicating the welding machine has reached the working temperature.

- Cut the pipe at right angles to the pipe axis using suitable pipe cutter.
- Remove any burrs or cutting chips by deburring the cutting area.
- Mark the welding depth on the pipe using suitable marker.
- Insert the end of the pipe without turning into the heating sleeve up to the marked welding depth and at the same time slide the fitting without turning into the other side of the heating tool up to the stop. It is essential to observe the mentioned heating times (refer to the below table)
- Leave the pipe and fitting into the heating tool until the heating time is elapsed.
- At the end of the heating time, remove the pipe and fitting from the heating tool and push them immediately against each other up to the mark indicating the welding depth. At this stage the depth mark will be covered with the welding bead.
- During this process, do not rotate the pipe and fitting relative to each other.
- Allow the joint to cool fully before using.

STEP 01



STEP 02



RESULT

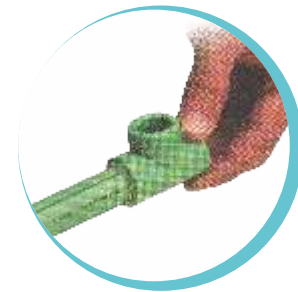

HOLE REPAIRING

If a hole is accidentally made in the pipe (with a drill bit or screws) and if the hole is in only one side of the pipe, it can be repaired using the hole repairing die, bearing in mind that the pipe size must be compatible with the die diameter.

THE REPAIR PROCEDURE IS AS FOLLOWS:

- Clean and dry the part to be repaired.
- Fit the male part of the Hole repairing die into the hole; it must melt the surface to be adjusted by the operator to suit the pipe thickness, to ensure that the die cannot be inserted too far and melt the other side of the pipe. To make this adjustment, undo the screw which fixes the bush and then move it along the die.
- At same time as the male part of the die melts the area around the hole, the female part melts the repair bar usually supplied with die. Once the heating time has passed (5sec.) the repair bar must be inserted in the hole. When this operation is complete, wait for everything to cool and then cut off the excess part of the repair bar.
- If the diameter of the hole to be repaired is greater than that of the die, or both sides of the pipe are punctured, the piece of pipe must be cut out and the repair made using normal pipe fittings.

STEP 01

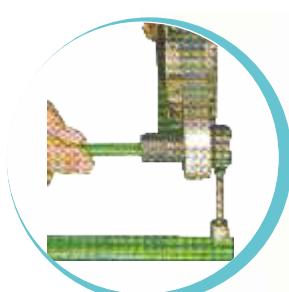

STEP 02



RESULT



FUSION TECHNIQUE II

WELD-IN SADDLE TECHNIQUE

Branches can easily be made by weld-in saddles, even at a later stage of installation. By using weld-in saddles you save material and time. Whereas in case of tees three joints have to be welded, installation of saddle is restricted to mounting the saddle and branch pipe only.

Steps Follows

- Drill the pipe
- Warm up the saddle
- Pipe wall and outside pipe
- Connect the elements

STEP 01



STEP 02



RESULT



ADVANCED BUTT WELDING TECHNOLOGY

KPT is having advanced US and Italian made machines to perform butt welding procedures on sizes above 110MM. Internationally butt jointing is the most suitable and acceptable procedure for sizes like 160MM, 200MM, 250MM and beyond to adhere to the best quality and durable international standards

Step 01



Step 02



Step 02



Result



Joining method of KPT PPR-C piping systems

CUTTING

1. Cut the pipe right angle to its axis using burr free cutter.
2. Ensure that pipes is free from burrs or cutting chip
3. Clean the pipe & fitting perfectly before welding.
4. Mark welding depth at the end of pipes.

HEATING

1. Mount the suitable dies on heating element of welding machine according to the diameter of Pipe and fitting to be welded.
2. Connect the welding machine to 220/230 volts A.C. power supply.
3. Select 260 Deg. C. temperatures on the welding machine thermostat.
4. Wait for reaching the required working temperature.
5. Insert the pipe and the fitting in the dies by exerting light pressure.
6. For heating time, refer the table given for different sizes of Pipes.

WELDING

1. After heating, quickly insert pipe into the fitting by exerting light pressure.
2. Any misalignment should be corrected immediately after insertion to avoid any Stress in the weld.
3. Allow the joint to cool as per cooling time given in table. This type of connection ensures perfect sealing even under the severe working Conditions.

Recommended Time For PPR Systems Fusion Joints

PIPE DIA. (MM)	WELDING MACHINE TEMPERATURE °C			WELDING DEPTH (MM)	HEATING TIME (SEC)	WELDING TIME (SEC)	COOLING TIME (MIN)
	PN-10	PN-16	PN-20				
16	230- 240	240- 250	250- 260	14.0	6	4	2
20				14.5	6	4	2
25				16.0	7	4	2
32				18.0	8	6	4
40				20.5	12	6	4
50				23.5	18	6	4
63				27.5	24	8	6
75				30.0	30	8	6
90				32.5	40	8	6
110				37.0	50	10	8
160				42.0	60	15	10

Recommended Time For PPR Systems Butt Joint

PIPE DIA. (MM)	WELDING MACHINE TEMPERATURE °C	HEATING TIME (MIN)	WELDING TIME (SEC)	COOLING TIME (MIN)
200	220-240	30	180	15-20
250	220-240	30	240	16-24
315	225-240	30	300	20-25
355	225-240	30	360	25-30
400	225-240	30	420	30-35

KPT PPR C Fittings

COUPLING

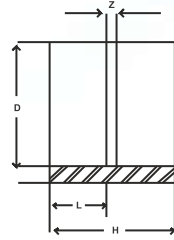

CODE	SIZE	D	L	Z	H
KPT C-0012	16MM	15.4	16	1.6	33.6
KPT C-0001	20 MM	19.2	14.5	3.9	32.9
KPT C-0002	25 MM	24.1	18.0	2.6	38.6
KPT C-0003	32 MM	31.0	18.4	3.0	39.8
KPT C-0004	40 MM	38.9	20.7	3.4	44.8
KPT C-0005	50 MM	48.0	24.4	3.1	51.9
KPT C-0006	63 MM	60.7	28.2	8.2	64.6
KPT C-0007	75 MM	71.9	31.5	4.0	67.0
KPT C-0008	90 MM	86.4	32.5	6.1	71.1
KPT C-0009	110 MM	106.8	38.8	3.0	80.6
KPT C-0011	125 MM	122.0	44.0	8.7	96.7
KPT C-0010	160 MM	153.0	42.5	5.4	90.4

ELBOW 90°

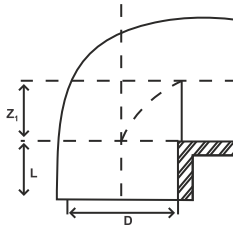

CODE	SIZE	D	L	Z	H
KPT E90-0020	16MM	15.5	14.4	8.5	34.3
KPT E90-0021	20 MM	19.1	15.5	10.9	40.0
KPT E90-0022	25 MM	24.2	16.9	14.1	47.4
KPT E90-0023	32 MM	31.1	18.0	16.4	54.2
KPT E90-0024	40 MM	39.5	20.0	20.0	66.2
KPT E90-0025	50 MM	48.4	23.8	26.2	80.3
KPT E90-0026	63 MM	60.5	27.4	32.2	98.2
KPT E90-0027	75 MM	72.6	31.5	38.0	115.4
KPT E90-0028	90 MM	86.8	33.0	44.7	130.6
KPT E90-0029	110 MM	106.5	39.0	54.8	160.6
KPT E90-0036	125MM	123.6	43.0	71.0	150.0
KPT E90-0030	160 MM	153.6	45.0	78.7	220.8
KPT E90-0031	200MM
KPT E90-0032	250MM
KPT E90-0033	315MM
KPT E90-0034	355MM
KPT E90-0035	400MM

ELBOW 45°

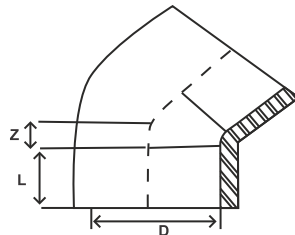

CODE	SIZE	D	L	Z
KPT E45-0041	20 MM	19.3	15.5	6.0
KPT E45-0042	25 MM	23.7	17.6	7.0
KPT E45-0043	32 MM	30.6	16.5	8.0
KPT E45-0044	40 MM	38.2	21.3	9.0
KPT E45-0045	50 MM	47.7	22.5	12.0
KPT E45-0046	63 MM	60.0	26.0	13.0
KPT E45-0047	75 MM	72.5	26.7	20.0
KPT E45-0048	90 MM	86.8	34.5	32.0
KPT E45-0049	110 MM	106.2	35.3	40.0
KPT E45-0056	125 MM
KPT E45-0050	160 MM	154.9	48.2	50.0
KPT E45-0051	200 MM
KPT E45-0052	250 MM
KPT E45-0053	315 MM
KPT E45-0054	355 MM
KPT E45-0055	400 MM

EQUAL TEE

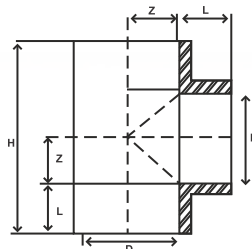

CODE	SIZE	D	L	Z	H
KPT ET-0060	16MM	15.3	14.6	8.9	46.9
KPT ET-0061	20 MM	19.3	15.8	10.5	52.6
KPT ET-0062	25 MM	24.2	18.0	12.7	61.4
KPT ET-0063	32 MM	31.4	20.2	16.1	72.5
KPT ET-0064	40 MM	39.0	20.3	20.9	82.4
KPT ET-0065	50 MM	48.6	24.4	24.5	97.8
KPT ET-0066	63 MM	61.7	27.4	32.6	120.0
KPT ET-0067	75 MM	72.2	31.3	36.7	136.0
KPT ET-0068	90 MM	86.9	32.9	47.1	160.0
KPT ET-0069	110 MM	106.7	38.8	55.3	188.2
KPT ET-0076	125 MM	122.2	42.2	101.3	287.0
KPT ET-0070	160 MM	153.7	45.0	85.0	260.0
KPT ET-0071	200MM
KPT ET-0072	250MM
KPT ET-0073	315MM
KPT ET-0074	355MM
KPT ET-0075	400MM

REDUCING ELBOW

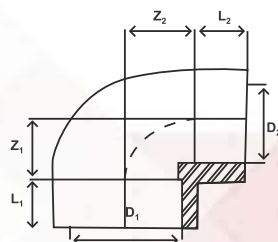

CODE	SIZE	D1	D2	L1	L2	Z1	Z2
KPT RE-0121	25/20	24.0	19.2	18.5	16.0	17.8	14.4
KPT RE-0122	32/20	31.3	19.2	21.1	16.0	18.3	18.0
KPT RE-0123	32/25	31.3	24.2	20.0	17.8	22.2	20.7
KPT RE-0124	40/20	38.7	19.2	21.6	16.3	19.6	24.2
KPT RE-0125	40/25	38.7	24.2	21.6	17.8	21.4	20.7
KPT RE-0126	40/32	38.6	31.2	21.9	19.8	24.2	25.3

REDUCER

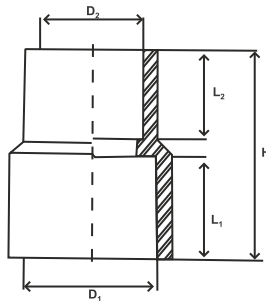

CODE	SIZE	D1	D2	L1	L2	H
KPT R-0081	25/20	24.0	19.2	18.5	15.7	38.1
KPT R-0082	32/20	31.3	19.2	20.0	15.7	39.3
KPT R-0083	32/25	31.4	24.4	21.0	18.4	41.7
KPT R-0084	40/20	38.7	19.3	22.9	16.9	48.0
KPT R-0085	40/25	39.0	24.2	24.2	18.0	48.5
KPT R-0086	40/32	38.6	31.0	21.1	18.8	44.9
KPT R-0087	50/20	48.0	18.8	24.6	16.6	44.5
KPT R-0088	50/25	48.0	23.8	24.5	16.2	45.6
KPT R-0089	50/32	48.0	31.1	24.4	18.0	48.1
KPT R-0090	50/40	48.2	38.8	24.3	20.9	48.2
KPT R-0091	63/20	60.9	19.2	28.2	15.9	48.3
KPT R-0092	63/25	60.7	24.1	28.2	18.0	49.5
KPT R-0093	63/32	60.6	30.7	28.0	18.0	48.0
KPT R-0094	63/40	60.8	38.3	25.3	25.5	56.8
KPT R-0095	63/50	60.9	48.2	29.2	25.8	64.8
KPT R-0126	75/20	72.5	19.0	42.7	21.1	63.8
KPT R-0125	75/25	72.5	24.3	42.7	21.1	63.8
KPT R-0124	75/32	72.5	31.0	42.7	21.1	63.8
KPT R-0097	75/40	72.2	38.7	31.6	22.5	63.6
KPT R-0098	75/50	72.1	48.4	31.7	27.0	63.2
KPT R-0099	75/63	71.8	60.9	31.4	30.0	67.0
KPT R-0123	90/20	87.3	19.0	43.5	27.0	70.5
KPT R-0122	90/25	87.3	24.1	43.5	27.0	70.5
KPT R-0121	90/32	87.3	31.0	42.5	27.0	70.5
KPT R-0120	90/40	87.3	38.9	42.5	27.0	70.5
KPT R-0100	90/50	86.5	48.1	33.0	26.3	70.0
KPT R-0101	90/63	86.6	60.9	32.8	29.9	68.8
KPT R-0102	90/75	86.7	72.7	37.2	31.5	71.7
KPT R-0119	110/20	106.8	19.0	58.1	19.5	76.0
KPT R-0118	110/25	106.8	24.0	53.3	19.2	76.0
KPT R-0117	110/32	106.8	31.0	57.6	19.5	76.0
KPT R-0116	110/40	106.8	39.0	56.6	19.3	76.0
KPT R-0103	110/50	106.8	48.4	38.9	26.0	76.0
KPT R-0104	110/63	106.8	61.2	38.9	30.1	76.0
KPT R-0105	110/75	106.8	72.6	38.9	31.8	76.0
KPT R-0106	110/90	106.8	86.6	38.9	33.0	76.0
KPT R-0188	125/110	122.2	104.3	43.0	40.0	96.0
KPT R-0115	160/20	155.3	18.9	61.8	29.5	91.2
KPT R-0114	160/25	155.3	23.9	61.8	29.5	91.2
KPT R-0113	160/32	155.3	30.6	61.8	29.5	91.2
KPT R-0112	160/40	155.3	38.7	61.8	29.5	91.2
KPT R-0111	160/50	155.3	48.5	61.8	29.5	91.2
KPT R-0110	160/63	155.3	61.8	61.8	29.5	91.2
KPT R-0109	160/75	155.3	73.5	61.8	29.5	91.2
KPT R-0108	160/90	155.3	86.5	61.8	29.5	91.2
KPT R-0107	160/110	155.3	106.3	61.8	29.5	91.2
KPT R-0188	160/125	157.3	122.1	43.0	40.0	92.1

REDUCING TEE

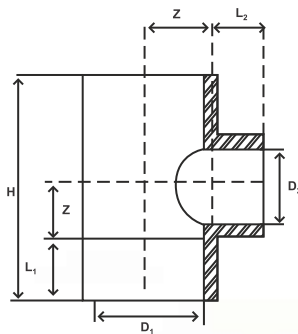

CODE	SIZE	D1	D2	L1	L2	Z	H
KPT RT-0141	25/20/25	24.2	19.1	17.6	16.2	10.8	56.8
KPT RT-0142	32/20/32	31.1	19.1	19.8	16.5	11.3	62.2
KPT RT-0143	32/25/32	31.4	24.2	20.0	17.8	13.4	66.8
KPT RT-0144	40/20/40	39.0	19.1	21.4	16.5	11.1	65.0
KPT RT-0145	40/25/40	38.8	24.2	21.4	17.6	13.5	69.8
KPT RT-0146	40/32/40	38.8	31.0	21.4	19.5	16.8	76.4
KPT RT-0147	50/20/50	48.4	19.1	24.4	18.1	24.5	97.7
KPT RT-0148	50/25/50	48.6	24.1	24.3	17.9	24.7	98.0
KPT RT-0149	50/32/50	48.6	30.5	24.3	18.8	24.6	97.8
KPT RT-0150	50/40/50	48.6	38.7	22.4	22.0	26.1	96.9
KPT RT-0151	63/20/63	61.2	19.0	27.5	16.2	32.2	119.4
KPT RT-0152	63/25/63	61.3	23.8	27.5	19.4	32.2	119.4
KPT RT-0153	63/32/63	61.3	30.8	27.5	19.3	32.2	119.4
KPT RT-0154	63/40/63	61.3	38.9	27.3	22.5	32.4	119.4
KPT RT-0155	63/50/63	61.2	48.0	27.4	25.8	32.3	119.4
KPT RT-0185	75/20/75	72.5	19.0	31.4	15.9	26.4	115.5
KPT RT-0184	75/25/75	72.5	24.0	31.4	17.6	26.4	115.5
KPT RT-0183	75/32/75	72.5	30.9	31.4	19.7	26.4	115.5
KPT RT-0156	75/40/75	72.3	38.4	31.4	20.3	26.4	115.5
KPT RT-0157	75/50/75	72.3	47.9	31.4	29.8	26.4	115.5
KPT RT-0158	75/63/75	72.2	60.2	31.4	29.8	26.4	115.5
KPT RT-0182	90/20/90	86.5	19.0	32.8	15.6	31.3	128.1
KPT RT-0181	90/25/90	86.5	24.0	32.8	17.6	31.3	128.1
KPT RT-0180	90/32/90	86.5	31.0	32.8	19.5	31.3	128.1
KPT RT-0179	90/40/90	86.5	38.6	32.8	21.2	31.3	128.1
KPT RT-0159	90/50/90	86.5	48.1	32.8	26.0	31.3	128.1
KPT RT-0160	90/63/90	86.5	61.2	32.8	30.1	31.3	128.1
KPT RT-0161	90/75/90	86.5	72.4	32.9	31.7	46.9	159.5
KPT RT-0178	110/20/110	106.5	19.0	38.7	15.8	38.5	154.3
KPT RT-0177	110/25/110	106.5	24.2	38.7	17.7	38.5	154.3
KPT RT-0176	110/32/110	106.5	31.0	38.7	19.7	38.5	154.3
KPT RT-0175	110/40/110	106.5	38.9	38.7	21.5	38.5	154.3
KPT RT-0162	110/50/110	106.5	48.6	38.9	26.2	38.3	154.3
KPT RT-0163	110/63/110	106.7	61.3	39.0	30.2	38.2	154.3
KPT RT-0164	110/75/110	106.4	72.5	39.0	32.0	38.2	154.3
KPT RT-0165	110/90/110	106.7	87.1	38.9	33.0	54.8	187.4
KPT RT-0247	125/110/125	122.5	107.5	44.0	44.0	64.0	216.0
KPT RT-0174	160/20/160	155.4	19.0	45.0	15.8	80.9	251.8
KPT RT-0173	160/25/160	155.4	23.8	45.0	18.5	80.9	251.8
KPT RT-0172	160/32/160	155.4	31.0	45.0	19.5	80.9	251.8
KPT RT-0171	160/40/160	155.4	38.9	45.0	21.5	80.9	251.8
KPT RT-0170	160/50/160	155.4	48.8	45.0	25.4	80.9	251.8
KPT RT-0169	160/63/160	157.5	61.9	45.0	27.6	80.9	251.8
KPT RT-0168	160/75/160	157.5	73.9	45.0	32.1	80.9	251.8
KPT RT-0167	160/90/160	157.5	88.5	45.0	33.0	80.9	251.8
KPT RT-0166	160/110/160	157.5	107.4	45.0	44.9	80.9	251.8
KPT RT-0188	200/90/200
KPT RT-0187	200/110/200
KPT RT-0248	200/125/200
KPT RT-0186	200/160/200
KPT RT-0199	250/90/250
KPT RT-0198	250/110/250
KPT RT-0249	250/125/250
KPT RT-0197	250/160/250
KPT RT-0196	250/200/250
KPT RT-0209	315/160/315
KPT RT-0208	315/200/315
KPT RT-0207	315/250/315
KPT RT-0223	355/160/355
KPT RT-0222	355/200/355
KPT RT-0221	355/250/355
KPT RT-0220	355/315/355
KPT RT-0237	400/160/400
KPT RT-0236	400/200/400
KPT RT-0235	400/250/400
KPT RT-0234	400/315/400
KPT RT-0233	400/355/400

SLIP ON (PPR C STEEL INLAY FLANGE)

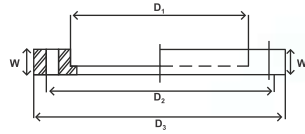
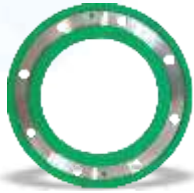

CODE	SIZE	PCD	(PPR +MS) Wall thickness	Flange OD.	Flange ID.	No. of Hole	Bolt Dia
KPT SIF-0351	20 MM	73.0	16.9	113.4	32.0	4	12.7
KPT SIF-0352	25 MM	82.6	17.0	126.2	37.1	4	12.7
KPT SIF-0353	32 MM	87.6	16.7	136.0	44.4	4	12.7
KPT SIF-0354	40 MM	98.4	17.8	149.7	51.2	4	12.7
KPT SIF-0355	50 MM	114.3	20.7	170.8	63.2	4	15.9
KPT SIF-0356	63 MM	127.0	20.7	183.5	82.6	4	15.9
KPT SIF-0357	75 MM	146.1	21.6	204.9	98.3	4	15.9
KPT SIF-0358	90 MM	165.1	23.6	222.7	114.8	4	15.9
KPT SIF-0359	110 MM	177.8	25.6	235.6	136.9	4	15.9
KPT SIF-0360	125 MM	209.6	28.5	273.7	160.1	8	15.9
KPT SIF-0361	160 MM	260.4	25.0	345.0	196.0	8	15.9
KPT SIF-0362	200 MM	292.1	26.0	366.0	218.0	8	15.9
KPT SIF-0363	250 MM	355.6	27.8	430.0	272.0	8	15.9
KPT SIF-0264	315 MM	406.4	30.0	492.0	320.0	12	19.1

FLANGE CORE(STUB END)

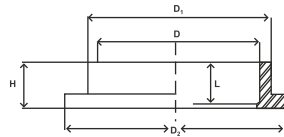

CODE	SIZE	D	D1	D2	L	H
KPT FC-0214	20 MM	19.2	29.9	44.6	20.7	24.2
KPT FC-0215	25 MM	24.1	33.9	49.7	20.0	24.0
KPT FC-0201	32 MM	31.1	42.9	50.5	19.9	23.3
KPT FC-0202	40 MM	31.1	49.6	60.2	20.3	25.8
KPT FC-0203	50 MM	48.1	62.6	72.3	22.2	27.2
KPT FC-0204	63 MM	61.0	80.7	95.0	20.9	35.4
KPT FC-0205	75 MM	72.6	95.0	111.3	31.9	39.0
KPT FC-0206	90 MM	87.1	111.8	129.4	24.2	42.1
KPT FC-0207	110 MM	106.8	133.3	151.0	25.4	43.3
KPT FC-0215	125 MM	123.8	157.6	179.8	43.4	68.0
KPT FC-0208	160 MM	155.0	194.4	214.0	31.0	52.8
KPT FC-0200	200MM	166.1	211.0	251.5	54.8	80.3
KPT FC-0210	250MM	213.8	261.4	312.0	80.5	84.4
KPT FC-0211	315MM	253.5	310.5	380.0	71.0	94.0
KPT FC-0212	355MM	300.0	355.0	427.0	63.8	119.0
KPT FC-0213	400MM	352.0	400.0	477.0	70.0	117.0

SLIP-ON (PPR FLANGES)

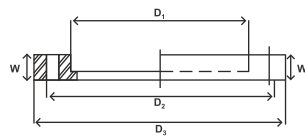

CODE	SIZE	D1	D2	D3	W
KPT F-0230	20 MM	31.5	67.6	112	17.7
KPT F-0231	25 MM	36.8	73.2	112	17.8
KPT F-0221	32 MM	43.6	97.0	115.7	20.6
KPT F-0222	40 MM	50.0	109.0	128.0	21.6
KPT F-0223	50 MM	62.5	122.0	140.7	22.5
KPT F-0224	63 MM	83.0	141.4	157.4	24.3
KPT F-0225	75 MM	97.0	175.3	172.3	26.2
KPT F-0226	90 MM	113.7	178.3	194.8	26.4
KPT F-0227	110 MM	135.7	197.9	216.0	30.6
KPT F-0229	125 MM	157.0	208.0	257.0	33.2
KPT F-0288	160 MM	195.8	266.0	292.0	35.5

PLAIN UNION

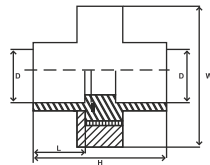

CODE	SIZE	D	L	W	H
KPT U-0365	20 MM	19.2	17.7	52.2	44.4
KPT U-0366	25 MM	24.2	18.6	51.4	55.2
KPT U-0367	32 MM	31.2	22.1	61.5	67.5
KPT U-0368	40 MM	39.2	29.2	79.0	79.9
KPT U-0369	50 MM	47.7	23.6	78.0	96.1
KPT U-0370	63 MM	60.7	27.7	89.0	107.6

4WAY/CROSS TEE

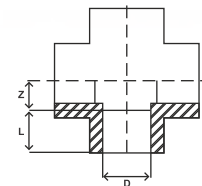

CODE	SIZE	D	L	Z
KPT CT-0261	20 MM	18.8	15.5	15.4
KPT CT-0262	25 MM	24.1	17.1	24.9
KPT CT-0263	32 MM	30.6	17.8	32.2
KPT CT-0264	40 MM	38.0	20.8	39.2
KPT CT-0265	50 MM	48.0	21.3	52.2
KPT CT-0266	63 MM	60.7	23.3	63.6

PIPE CLAMP

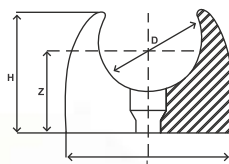

CODE	SIZE	D	L	Z	H
KPT PC-0287	16 MM	15.2	23.0	14.1	26.0
KPT PC-0281	20 MM	18.9	27.0	19.2	31.0
KPT PC-0282	25 MM	24.0	32.0	21.0	36.0
KPT PC-0283	32 MM	30.7	39.5	27.5	43.5
KPT PC-0284	40 MM	39.1	48.3	30.9	49.8
KPT PC-0285	50 MM	50.0	60.0	37.3	61.5
KPT PC-0286	63 MM	63.0	74.7	45.0	75.3

LONG PLUG

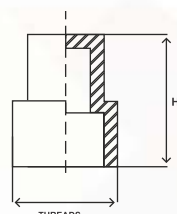

CODE	SIZE	THREADS	H
KPT LP-0301	1/2"	1/2"	69.7
KPT LP-0302	3/4"	3/4"	62.2
KPT LP-0303	1"	1"	73.6

TANK CONNECTOR

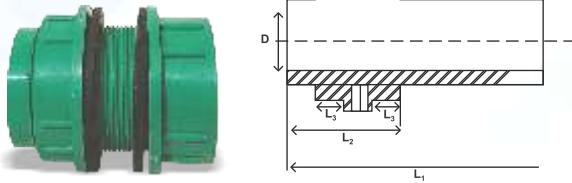

CODE	SIZE	D	L1	L2	L3
KPT TC-0371	20 MM	19.2	69.0	43.6	15.2
KPT TC-0372	25 MM	24.1	69.0	52.5	19.5
KPT TC-0373	32 MM	30.6	74.3	54.5	21.5
KPT TC-0374	40 MM	38.4	88.4	55.3	25.6
KPT TC-0375	50 MM	48.3	96.7	58.4	24.6
KPT TC-0276	63 MM	60.7	101.5	65.5	27.0

BALL VALVE PLASTIC (FOR COLD WATER)

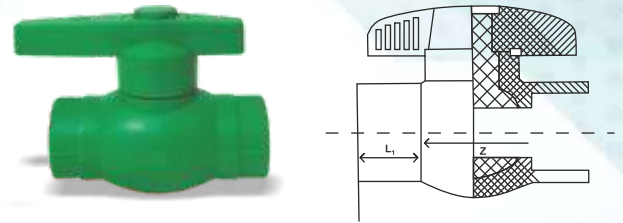

CODE	SIZE	D1	D2	L	Z	H
KPT PBV-0377	20 MM	19.10	19.35	16.15	41.35	64.25
KPT PBV-0378	25 MM	23.80	24.30	18.00	41.20	72.70
KPT PBV-0379	32 MM	30.85	31.20	19.90	46.90	82.65
KPT PBV-0380	40 MM	38.25	38.95	25.38	52.44	97.25

BALL VALVE PLASTIC (FOR COLD WATER)

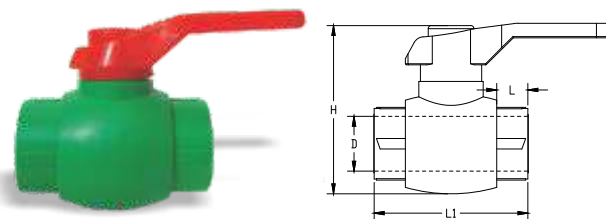

CODE	SIZE	D	L1	L	H
KPT PBV-0381	50 MM	48.8	125.0	33.0	122.0
KPT PBV-0382	63 MM	62.1	147.0	38.0	138.0

BRASS BALL VALVE (FOR HOT WATER)

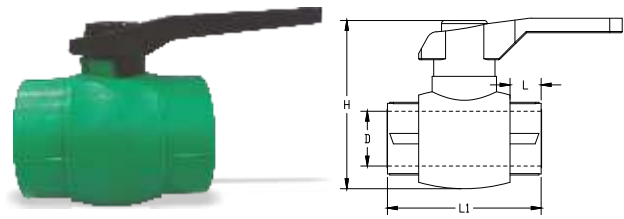

CODE	SIZE	D1	D2	L	Z	H
KPT BBV-0383	20 MM	18.90	19.35	20.90	26.50	70.55
KPT BBV-0384	25 MM	23.80	24.25	20.50	33.15	76.90
KPT BBV-0385	32 MM	30.80	31.10	24.00	37.65	86.70
KPT BBV-0386	40 MM	38.80	38.98	21.38	60.89	98.35
KPT BBV-0387	50 MM	48.90	49.10	22.80	68.20	122.25
KPT BBV-0388	63 MM	61.68	61.85	26.25	78.00	133.25

FLANGE END BALL VALVE



CODE	SIZE	Flange Ball Valve Bore ID. (mm)	Ball Valve Flange OD. (mm)	Flange Ball Valve No. of Hole	Ball Valve Flange Hole PCD. (mm)	Ball Valve Flange Hole Length/Wid th (mm)	Flange Ball Valve Height (mm)
KPT FEBV-0389	20 MM	18.5	100.0	4.0	71.0	16.5/15.0	142.8
KPT FEBV-0390	25 MM	24.1	122.0	4.0	84.8	18.8/13.8	158
KPT FEBV-0391	32 MM
KPT FEBV-0392	40 MM	37.55	138.00	4.00	101.56	22.10/15.90	101.55
KPT FEBV-0393	50 MM	49.67	167.40	4.00	116.05	24.60/17.80	116.10
KPT FEBV-0394	63 MM
KPT FEBV-0395	75MM	63.65	180.10	4.00	128.42	31.70/18.55	128.40
KPT FEBV-0396	90 MM	72.90	198.45	4.00	152.75	26.75/18.08	152.70
KPT FEBV-0397	110 MM	98.40	221.37	8.00	181.20	23.68/18.42	181.20

MALE THREADED COUPLING

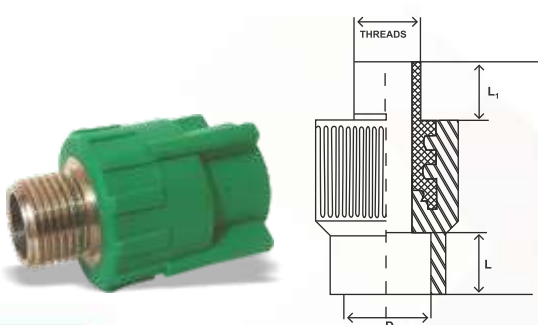

CODE	SIZE	THREADS	D	L	L1	H
KPT MTC-0398	16*1/2	1/2"	15.7	17.0	13.9	57.3
KPT MTC-0399	20*1/2	1/2"	19.2	16.2	14.2	57.0
KPT MTC-0400	25*1/2	1/2"	23.8	18.3	14.2	56.0
KPT MTC-0401	25*3/4	3/4"	24.1	18.2	14.1	59.1
KPT MTC-0402	32*1/2	1/2"	31.1	19.8	14.0	64.5
KPT MTC-0403	32*3/4	3/4"	31.1	20.3	14.2	67.8
KPT MTC-0404	32*1	1"	31.1	20.2	28.0	71.8
KPT MTC-0405	40*1	1"	38.7	21.6	28.0	76.0
KPT MTC-0406	40*1-1/4	1 1/4"	38.8	22.1	14.1	76.0
KPT MTC-0407	50*1-1/2	1 1/2"	48.9	25.5	21.3	80.0
KPT MTC-0408	63*2	2"	62.2	29.5	26.3	95.2
KPT MTC-0409	75*2-1/2	2 1/2"	72.0	32.4	24.9	100.5
KPT MTC-0410	90*3	3"	86.4	38.2	24.6	109.2
KPT MTC-0411	110*4	4"	104.9	38.1	25.5	119.0

FEMALE THREADED COUPLING

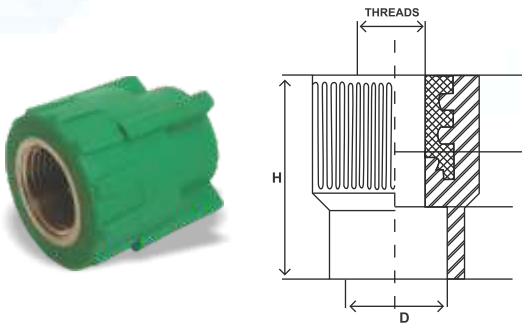

CODE	SIZE	THREADS	D	L	L1	H
KPT FTC-0412	16*1/2	1/2"	15.7	17.0	15.0	43.4
KPT FTC-0413	20*1/2	1/2"	19.2	16.0	15.0	43.2
KPT FTC-0414	20*3/4	3/4"	23.6	18.0	14.9	41.8
KPT FTC-0415	25*1/2	1/2"	23.6	18.0	14.9	41.8
KPT FTC-0416	25*3/4	3/4"	24.1	18.1	15.7	45.0
KPT FTC-0417	32*1/2	1/2"	31.1	20.0	15.0	50.5
KPT FTC-0418	32*3/4	3/4"	31.1	20.4	16.0	52.0
KPT FTC-0419	32*1	1"	31.1	20.2	17.8	54.7
KPT FTC-0420	40*1	1"	38.7	21.6	27.0	62
KPT FTC-0421	40*1-1/4	1 1/4"	38.8	22.1	18.0	62.0
KPT FTC-0422	50*1-1/2	1 1/2"	48.8	25.3	18.5	58.0
KPT FTC-0423	63*2	2"	61.5	28.6	25.6	68.1
KPT FTC-0424	75*2-1/2	2 1/2"	71.8	31.7	20.2	89.2
KPT FTC-0425	90*3	3"	86.5	38.0	21.9	101.5
KPT FTC-0426	110*4	4"	106.1	38.2	26.3	116.8

FEMALE THREADED TEE

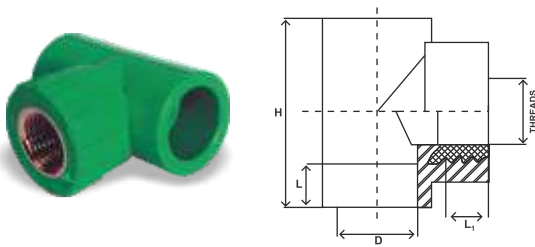

CODE	SIZE	THREADS	D	L	L1	H
KPT FTT-0427	20*1/2	1/2"	19.2	15.0	14.0	58.2
KPT FTT-0428	25*1/2	1/2"	24.2	14.9	14.0	62.2
KPT FTT-0429	25*3/4	3/4"	24.2	16.2	13.9	63.8
KPT FTT-0430	32*1/2	1/2"	31.3	15.0	14.2	78.0
KPT FTT-0431	32*3/4	3/4"	31.3	16.2	14.2	78.2
KPT FTT-0432	32*1	1"	31.2	17.7	15.8	77.8
KPT FTT-0433	40*1-1/4	1 1/4"	39.0	17.6	15.2	91.0

MALE THREADED TEE

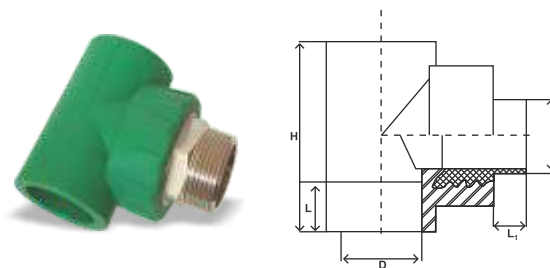

CODE	SIZE	THREADS	D	L	L1	H
KPT MTT-0434	20*1/2	1/2"	19.2	16.5	14.0	58.2
KPT MTT-0435	25*1/2	1/2"	24.2	18.2	14.0	62.2
KPT MTT-0436	25*3/4	3/4"	24.2	17.6	13.9	63.8
KPT MTT-0437	32*1/2	1/2"	31.3	20.0	14.2	78.0
KPT MTT-0438	32*3/4	3/4"	31.3	20.0	14.2	78.2
KPT MTT-0439	32*1	1"	31.2	20.0	15.8	77.8
KPT MTT-0440	40-1-1/4	1 1/4"	39.0	21.4	15.2	91.0

FEMALE THREADED ELBOW

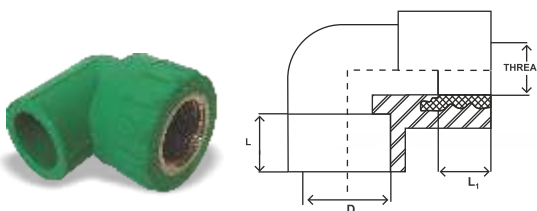

CODE	SIZE	THREADS	D	L	L1
KPT FTE-0441	20*1/2	1/2"	19.2	16.1	16.0
KPT FTE-0442	25*1/2	1/2"	24.1	17.9	15.0
KPT FTE-0443	25*3/4	3/4"	24.2	17.9	16.0
KPT FTE-0444	32*1/2	1/2"	31.2	20.2	15.0
KPT FTE-0445	32*3/4	3/4"	31.2	20.2	16.1
KPT FTE-0446	32*1	1"	31.2	20.3	18.3
KPT FTE-0447	40*1-1/4	1 1/4"	39.1	21.3	17.9

MALE THREADED ELBOW

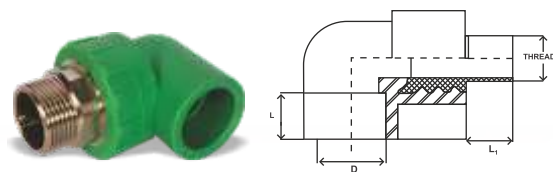

CODE	SIZE	THREADS	D	L	L1
KPT MTE-0448	20*1/2	1/2"	19.2	16.1	15.0
KPT MTE-0449	25*1/2	1/2"	24.1	17.9	15.0
KPT MTE-0450	25*3/4	3/4"	24.2	18.0	14.2
KPT MTE-0451	32*1/2	1/2"	31.3	21.0	14.3
KPT MTE-0452	32*3/4	3/4"	31.3	20.4	15.2
KPT MTE-0453	32*1	1"	31.3	20.1	27.0
KPT MTE-0454	40*1-1/4	1 1/4"	39.0	24.5	21.8

GATE VALVE

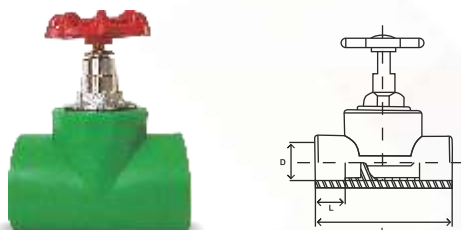

CODE	SIZE	D	L	L1
KPT GV-0455	20 MM	19.0	15.0	60.5
KPT GV-0456	25 MM	24.0	16.8	69.2
KPT GV-0457	32 MM	31.1	20.0	79.5
KPT GV-0458	40 MM	39.0	21.4	92.5
KPT GV-0459	50 MM	48.0	24.0	112.2
KPT GV-0460	63 MM	60.6	26.0	119.1
KPT GV-0461	75 MM	72.3	30.8	133.4
KPT GV-0462	90 MM	86.0	30.8	178.0
KPT GV-0463	110 MM	106.0	41.6	200.0

MALE THREADED UNION

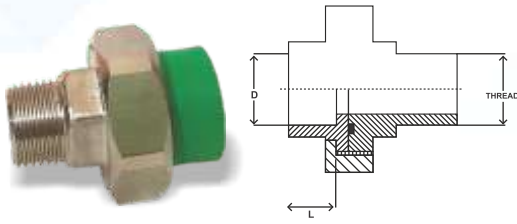

CODE	SIZE	THREADS	D	L
KPT MTU-0464	20*1/2	1/2"	19.2	17.8
KPT MTU-0465	25*3/4	3/4"	24.2	19.0
KPT MTU-0466	32*1	1"	31.3	23.5
KPT MTU-0467	40*1-1/4	1 1/4"	39.2	28.5
KPT MTU-0468	50*1-1/2	1 1/2"	47.6	24.6
KPT MTU-0469	63*2	2"	60.6	28.1

FEMALE THREADED UNION

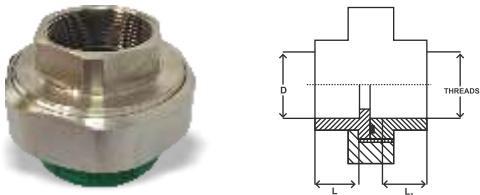

CODE	SIZE	THREADS	D	L	L1
KPT FTU-0470	20*1/2	1/2"	19.2	17.5	18.0
KPT FTU-0471	25*3/4	3/4"	24.2	19.0	18.5
KPT FTU-0472	32*1	1"	31.2	23.6	20.4
KPT FTU-0473	40*1-1/4	1 1/4"	39.2	28.4	23.0
KPT FTU-0474	50*1-1/2	1 1/2"	47.7	23.6	31.5
KPT FTU-0475	63*2	2"	60.6	28.4	28.7

DOUBLE UNION BALL VALVE

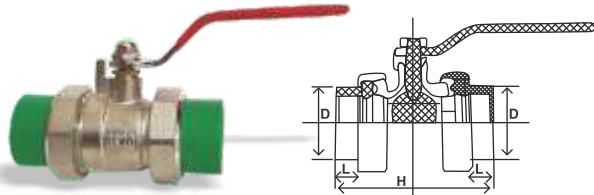

CODE	SIZE	D	L	H
KPT DUBV-0476	20 MM	18.7	16.3	84.1
KPT DUBV-0477	25 MM	23.8	17.4	95.7
KPT DUBV-0478	32 MM	30.8	21.8	107.3
KPT DUBV-0479	40 MM	38.9	25.2	125.3
KPT DUBV-0480	50 MM	48.7	27.3	147.0
KPT DUBV-0481	63 MM	61.4	29.0	168.5

BY PASS BEND

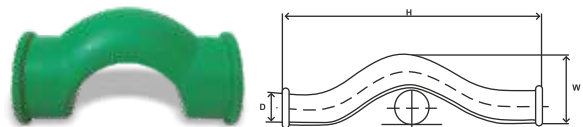

CODE	SIZE	D	W	H
KPT BPB-0483	20 MM	19.3	40	86
KPT BPB-0483	25 MM	23.9	47.0	94.9
KPT BPB-0484	32 MM	31.2	58.0	106.0
KPT BPB-0485	40 MM	37.9	80.0	133.0

WELD IN SADDLE REDUCER

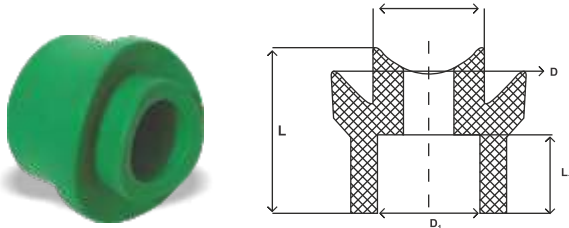

CODE	SIZE	D	D1	L	L1
KPT WIS R-0496	63/32	48.8	30.8	40.2	19.9
KPT WIS R-0497	75/32	48.8	30.8	40.2	19.9
KPT WIS R-0498	90/20	78.5	19.1	62.1	15.5
KPT WIS R-0499	90/25	78.5	24.2	62.1	17.5
KPT WIS R-0500	90/32	78.5	31.0	62.1	19.1
KPT WIS R-0501	90/40	79.2	38.9	62.1	21.4
KPT WIS R-0502	90/50	79.2	48.8	62.1	21.7
KPT WIS R-0503	90/63	79.2	62.7	62.1	27.5
KPT WIS R-0504	110/20	88.0	19.0	66.7	15.5
KPT WIS R-0505	110/25	88.0	24.0	66.7	17.3
KPT WIS R-0506	110/32	88.0	31.0	66.7	19.3
KPT WIS R-0507	110/40	88.0	39.1	66.7	21.5
KPT WIS R-0508	110/50	88.0	48.8	66.7	25.2
KPT WIS R-0509	110/63	88.0	62.4	66.7	27.4
KPT WIS R-0510	160/20	89.8	19.0	62.0	15.6
KPT WIS R-0511	160/25	89.8	23.9	62.0	17.3
KPT WIS R-0512	160/32	89.8	31.2	62.0	19.4
KPT WIS R-0513	160/40	89.8	38.8	62.0	21.3
KPT WIS R-0514	160/50	89.8	49.1	62.0	21.5
KPT WIS R-0515	160/63	89.8	62.5	62.0	27.3
KPT WIS R-0516	200/20	90.2	19.1	66.0	15.6
KPT WIS R-0517	200/25	90.2	24.1	66.0	17.7
KPT WIS R-0518	200/32	90.2	31.2	66.0	19.4
KPT WIS R-0519	200/40	90.2	39.0	66.0	21.4
KPT WIS R-0520	200/50	90.2	48.8	66.0	25.0
KPT WIS R-0521	200/63	90.2	62.5	66.0	27.3

WELD IN SADDLE FEMALE THREADED COUPLING

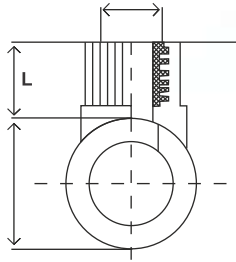

CODE	SIZE	THREADS	L	L1	H
KPT WIS M-0486	160*1/2	1/2"	16.3	49.2	41.3
KPT WIS M-0487	110*1/2	1/2"	16.3	49.2	41.3
KPT WIS M-0489	90*1/2	1/2"	16.3	49.2	41.3
KPT WIS M-0490	75*1/2	1/2"	16.3	49.2	41.3
KPT WIS M-0491	63*1/2	1/2"	16.3	49.2	41.3
KPT WIS M-0492	160*3/4	3/4"	16.0	49.1	41.3
KPT WIS M-0493	110*3/4	3/4"	16.0	49.1	41.3
KPT WIS M-0494	90*3/4	3/4"	16.0	49.1	41.3
KPT WIS M-0495	75*3/4	3/4"	16.0	49.1	41.3
KPT WIS M-0496	63*3/4	3/4"	16.0	49.1	41.3

DOUBLE BATTERY TAP CONNECTOR



CODE	SIZE	THREADS	D	L	L1	L2	H
KPT DBTC F-0522	20*1/2	1/2"	19.1	17.3	248	101	30
KPT DBTC F-0523	25*1/2	1/2"	24.0	18.5	248	101	30

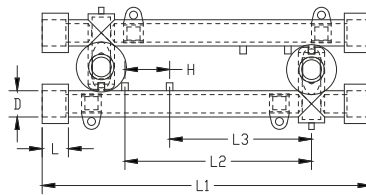

DOUBLE MALE THREADED TEE WITH DISK



CODE	SIZE	THREADS	D	L1	Z	H
KPT DMTWD -0524	20*1/2	1/2"	19.1	16.0	25.3	150
KPT DMTWD -0525	25*1/2	1/2"	24.0	18.0	25.2	150

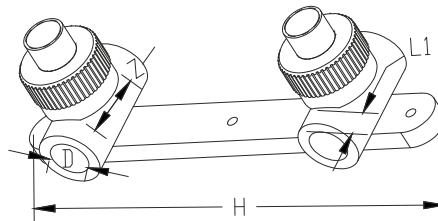

DOUBLE FEMALE THREADED TEE WITH DISK



CODE	SIZE	THREADS	D	L1	Z	L
KPT DFTWD -0526	20*1/2	1/2"	19.1	16.0	25.3	150
KPT DFTWD -0527	25*1/2	1/2"	24.0	18.0	25.2	150



DOUBLE MALE ELBOW WITH DISK



CODE	SIZE	THREADS	D	L	Z	T
KPT DMEWD -0528	20*1/2	1/2"	18.7	15.8	16.0	149.5
KPT DMEWD -0529	25*1/2	1/2"	24.0	17.6	16.2	149.5



DOUBLE FEMALE ELBOW WITH DISK



CODE	SIZE	THREADS	D	L	Z	T
KPT DFEWD -0530	20*1/2	1/2"	18.7	15.8	16.0	149.5
KPT DFEWD -0531	25*1/2	1/2"	24.0	17.6	16.2	149.5

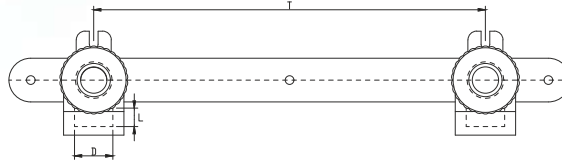

MALE THREADED ELBOW WITH DISK

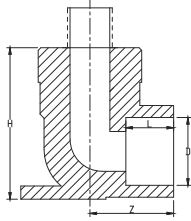

CODE	SIZE	THREADS	D	L	Z	H
KPT MTEWD -0532	20*1/2	1/2"	19.1	15.8	15.0	65
KPT MTEWD -0533	25*1/2	1/2"	24.0	17.6	16.2	70

FEMALE THREADED ELBOW WITH DISK

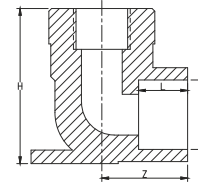

CODE	SIZE	THREADS	D	L	Z	H
KPT FTEWD -0534	20*1/2	1/2"	19.1	15.8	15.0	50
KPT FTEWD -0535	25*1/2	1/2"	24.0	17.6	16.2	55

MALE THREADED TEE WITH DISK

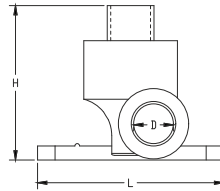
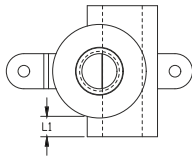

CODE	SIZE	THREADS	D	L1	Z	H
KPT MTTWD -0536	20*1/2	1/2"	19.1	16.0	56.0	64
KPT MTTWD -0537	25*1/2	1/2"	24.0	17.2	57.7	70

FEMALE THREADED TEE WITH DISK

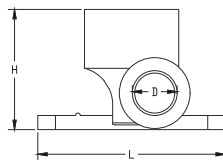
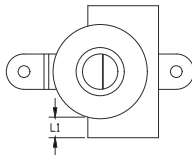

CODE	SIZE	THREADS	D	L1	Z	H
KPT FTTWD -0538	20*1/2	1/2"	19.1	16.0	56.0	50
KPT FTTWD -0539	25*1/2	1/2"	24.0	17.2	57.8	56

CONCEALED VALVE



CODE	SIZE	D	L	L1
KPT CV-0540	20 MM	19.0	15.0	60.5
KPT CV-0541	25 MM	24.3	17.2	68.1
KPT CV-0542	32 MM	31.0	20.0	79.7

pneumato
PNEUMATIC PIPES & FITTINGS

PNEUMATICS AND COMPRESSED AIR PLUMBING PIPING SYSTEM

With a service life of atleast 50 years once installed, tight and safe



connection heating & cooling



chilled water technology



swimming-pool technology



chemical transport



irrigation



wall heating



application in the field of ship building



district heating pipeline systems



geothermal

Pneumatic and Compressed Air Plumbing piping system

K.P.T. PneumatoPipes combine the advantages of FRP and plastic pipes and eliminate the disadvantages of both materials at the same time. The FRP is absolutely diffusion tight and reliably prevents oxygen or gases from permeating into the pipe. It compensates and reduces snap-back forces and heat expansion with changes in temperature. K.P.T. Pneumato pipes are being produced with latest German technology at its state of the art manufacturing unit at Dehradun, Uttarakhand, India. K.P.T. Pneumato pipes has been specially designed for the creation of primary and secondary network for compressed air, neutral gases & Vacuum. The FRP allows K.P.T. Pneumato Pipes to withstand high working pressure and prevent oxygen and gases from permeating into the pipe. K.P.T. Pneumato pipes are safe and reliable choice for compressed air, gas and oxygen supply.

K.P.T. PneumatoPipes consist of an overlapped FRP with an inner and outer layer of Polypropylene Random Copolymer (PPR-C). All the layers are permanently bonded together by intermediate adhesive layers. The FRP thickness of K.P.T. Pneumato pipes has been selected to meet compressive and flexural strength requirements. Most of the industries are now slowly moving away from MS/GI piping system for compressed air transportation owing to following problems:

Reinforcement Glass Fiber

The Sandwich Glass Reinforcement technology processed on Pneumato enables to withstand more pressure even in high temperature. Since Glass is non-conductor of heat, so there is lesser thermal expansion, this reduces sagging.

U.V. Resistant

New Pneumato technology being developed with carbon content blue layer which protects the pipes from UV rays in open sky.

Glass Insulation

Glass acts as non-conductor of heat. So the Sandwich Glass Reinforcement technology reduces the condensation, thus reduces the chances of moisture in Pneumato technology getting least.

Leaking zero

in fusion welded joints.

Rusting

Water condensation in compressed air system leads to rust formation even in joint areas of GI pipe welding, affecting costlier pneumatic equipments.

Installation Time

Threaded joints consume more time in existing repair work as well as in new projects where as fusion joints once conducted require no maintainance.

Pressure Drop

Rough inner surface in the above pipes leads to slight increase in pressure drop.

Cost

Aluminium/MS/GI piping systems are conventionally more expensive.

Atmospheric effects

Aluminium also reacts with most of the chemicals. If some chemicals are present in compressed air, that can equally effect aluminium pipes. Often aluminium pipes are available at the maximum size of 110mm only. Most of the fittings are in plastics material. These areas are then rendered mechanically weaker in the line.

K.P.T. Pneumato piping system (Blue Colour) will provide the right solution for all the above issues. KPT Pneumato compressed air application has the following features:

- 1 Compression - style fittings offer a tight, leak-free fit.
- 2 All fittings are corrosion-free and will not degrade or rust.
- 3 Smooth inner surface that reduces operational pressures required by motor/pump
- 4 High chemical resistance with no possibility of bacterial and moss reproduction within pipes.
- 5 Resistance to high temperature (110°C)
- 6 None crumbling and non-deforming properties
- 7 Non contracting diameters
- 8 Wide variety of size options to suit diverse needs from 16mm up to 355mm
- 9 K.P.T Pneumato piping joints are fusion joints and no external adhesives are used. Hence once fusion welding is done, pipes and fittings will turn into a homogeneous material and makes permanent joints.
- 10 Fusion welding technology is very simple. Any person can do it with little practice. K.P.T. will offer training and provide minimum spares to our clients to meet any emergency.

Technical Data of K.P.T. Pneumato Pipes:

S.No.	PROPERTY	(KPT-GF) PIPE
1	Thermal Conductivity	0.024
2	Coefficient Linear Thermal Expansion	1.0×10^{-4}
3	Flexural Modulus	1260
4	Tensile Strength at break	45
5	Melting Temperature Rate	160-165
6	Vicat Softening Temperature	145.3

Advantages of Pneumato Pipes:

1. Very less heat loss due to lesser thermal conductivity.
2. Lesser sagging because of very less thermal expansion.
3. High temperature and high pressure with stand capacity due to inbuilt GFR reinforcement layer.
4. Since having 0.1micron RA value and mirror finish inner surface, 40% to 60% lesser friction compared to other pipe.
5. Reduced thermal expansion will reduce clamping.
6. Style fittings offer a tight, leak free fit.
7. As a result of socket Fusion joint, 0% leakage.
8. 60% layer of glass fiber reinforcement in the pipe.
9. Excellent performance with long life in direct sunlight having UV resistant on the upper layer.
10. Reduced linear expansion coefficient, only 1/3 of that of normal PP-R
11. Higher strength and stability of dimension. It can stand 25% more pressure than PP-R at the same condition
12. Improved resistant to impulse under low temperature. It can used in 90 ° for a long time
13. With the same condition of pressure, wall thickness of PPR fiberglass pipe is thinner, increasing inner diameter of the pipe, bigger of the air flow.
14. Direct connect with water table within the health of non-toxic, good scalability, no formation of sphagnum.

Saving Time and Money-Life Cycle Cost

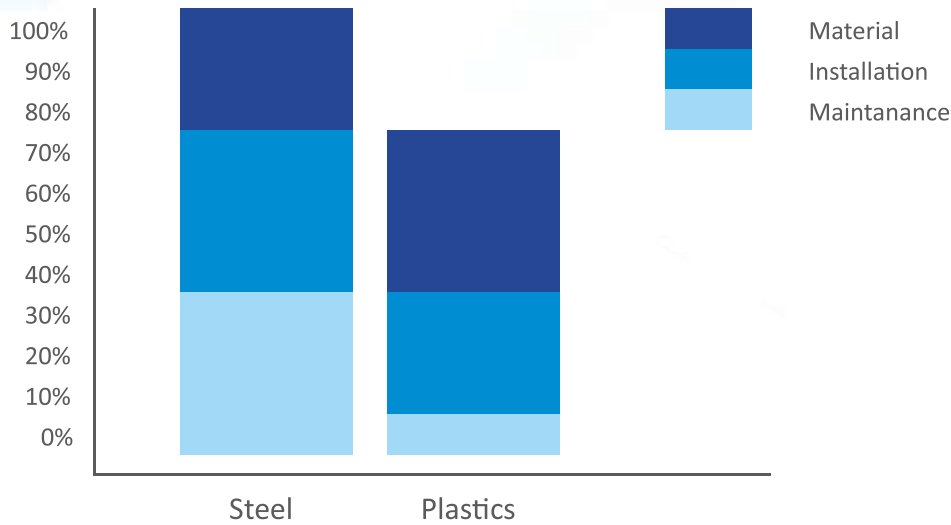

Applications

1. Compressed Air lines for hot and cold air
2. Solar Heaters, under floor heating
3. Effluent Treatment Plants (ETP)
4. Vacuum pipelines
5. Chilled Water Application and air conditioning
6. Instrument Air
7. Nitrogen Gas
8. Chemical Plants and aggressive fluids
9. Industrial Water and Wastewater
10. Flue-gas Desulfurization
11. Pulp and Paper Mills
12. Irrigation
13. Wall Heating
14. Application in the field of ship building
15. Pharmaceuticals
16. Suitable usage for more than 400 chemicals
17. Industrial waste applications
18. Water transmission lines
19. Pressure/forced mains sewers
20. Rehabilitation applications
21. Water distribution systems
22. Storm water Drainage
23. Above ground piping
24. Sewage Drainage
25. Re-lining, Slip-lining applications
26. Desalination Plants

Conclusions and Recommendations

1. KPT brand pipes and fittings are suitable for all applications better than other traditional thermoplastics.
2. KPT brand pipes and fittings are most suitable for potable hot and cold water in building services.
3. No maintenance, **Install it forget it**
4. Commercially viable
5. Adopted in various applications

For all size of KPT Pneumato Pipe and Fittings

Allowable working pressure for KPT Pneumato Pipe and Fittings

Temperature, in °C	Years of Service	Standard Dimension Ratio (SDR)			
		11	9	7.4	6
		PN-10	PN-12.5	PN-16	PN-20
Allowable working pressure, in bar					
10	1	20.5	28.8	34.8	43.8
	5	19.1	27.8	33.0	41.5
	10	18.5	27.5	31.9	40.1
	25	17.8	27.0	30.9	38.9
	50	17.3	26.6	30.0	37.9
20	1	18.8	25.1	29.8	37.5
	5	17.6	24.2	27.9	35.1
	10	17.1	23.9	27.1	34.1
	25	16.6	23.5	26.4	33.1
	50	16.1	23.2	25.5	32.1
30	1	16.0	21.7	25.3	31.9
	5	15.0	20.9	23.8	29.9
	10	14.5	20.6	22.9	28.9
	25	14.0	20.3	22.1	27.9
	50	13.6	19.9	21.6	27.3
40	1	13.5	18.6	21.4	26.9
	5	12.6	18.0	20.0	25.3
	10	12.3	17.6	19.5	24.5
	25	11.8	17.3	18.8	23.5
	50	11.5	17.0	18.1	22.9
50	1	11.4	16.0	18.0	22.8
	5	10.6	15.4	16.9	21.3
	10	10.3	15.1	16.4	20.6
	25	10.0	14.8	15.8	19.9
	50	9.6	14.5	15.3	19.3
60	1	9.5	13.4	15.1	19.1
	5	9.0	13.0	14.3	17.9
	10	8.6	12.7	13.8	17.3
	25	8.4	12.5	13.1	16.6
	50	8.0	12.2	12.6	15.9
70	1	8.1	11.3	12.9	16.3
	5	7.5	10.9	11.9	14.9
	10	7.4	10.7	11.6	14.6
	25	6.4	9.1	10.0	12.6
	50	5.4	7.6	8.4	10.6
80	1	6.9	9.5	10.8	13.6
	5	6.0	9.0	9.5	12.0
	10	5.0	7.4	7.9	10.0
	25	4.0	6.0	6.4	8.0
95	1	4.9	7.1	7.6	9.6
	5	3.1	4.6	5.0	6.3
	10	2.6	3.7	4.3	5.3
110	1	2.9	3.7	5.0	5.6
	5	2.0	2.6	3.0	3.5

Support Intervals

Pipe Diameters mm	Temperature									
	0°C	20°C	30°C	40°C	50°C	60°C	70°C	80°C	95°C	110°C
16mm	100	80	80	75	75	70	60	50	40	30
20mm	120	90	90	85	85	80	70	60	50	40
25mm	140	105	105	95	95	90	80	70	60	50
32mm	160	120	120	110	110	105	95	90	80	65
40mm	180	135	135	125	125	120	110	100	90	75
50mm	205	155	155	145	145	135	130	120	105	90
63mm	230	175	175	165	165	155	145	130	115	105
75mm	245	185	185	175	175	165	155	140	125	110
90mm	260	195	195	185	185	175	165	150	130	110
110mm	290	215	210	200	190	180	170	150	130	110
160mm	340	270	245	205	205	195	185	160	140	120
200mm	380	310	285	245	245	235	225	200	180	160
250mm	430	360	335	295	295	285	275	250	230	210
315mm	490	420	395	355	355	345	335	310	290	270
355mm	550	480	455	415	415	405	390	370	350	330
400mm	620	550	525	485	485	475	465	440	420	400

Support Intervals (CM)

KPT Pneumato Thermal Conductivity

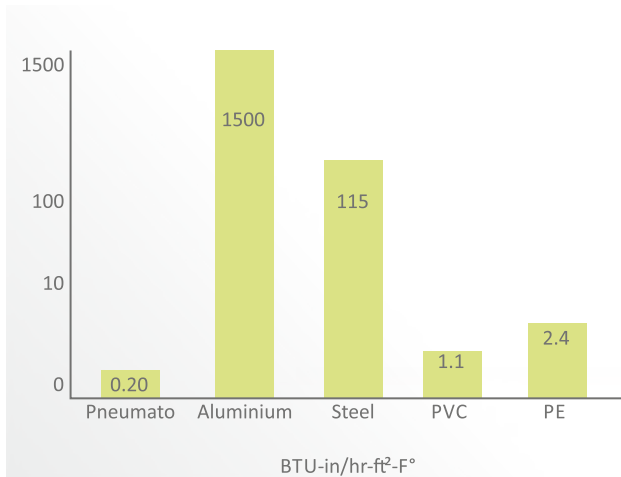

KPT Pneumato pipe Wall- Specific Gravity

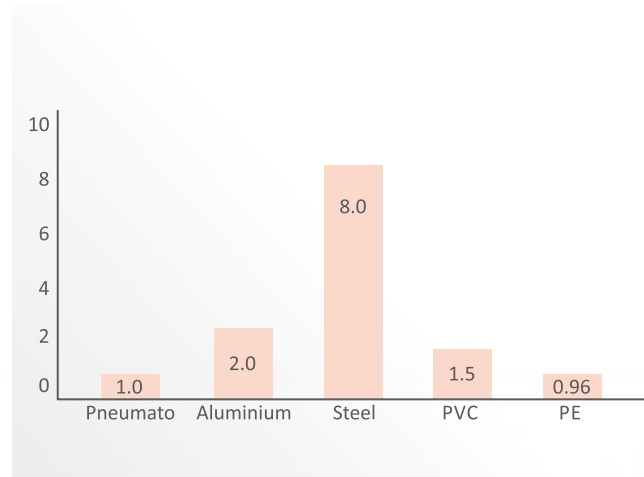

KPT Pneumato pipes and fitting coefficient of thermal expansion 1.0×10^{-4}

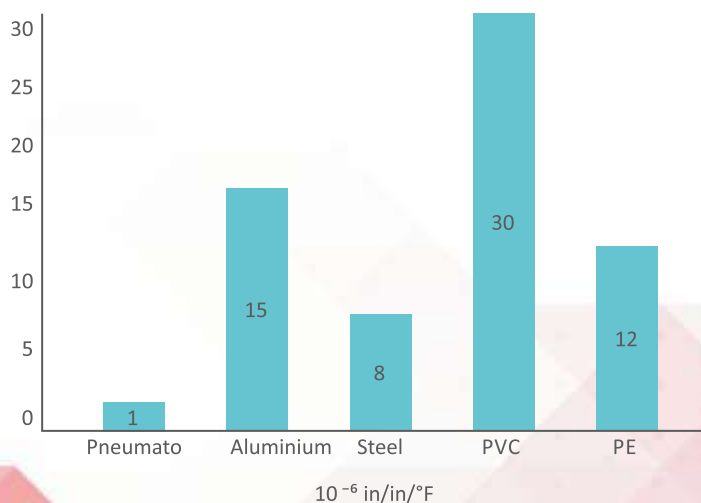

KPT Pneumato pipe Stress - Strain

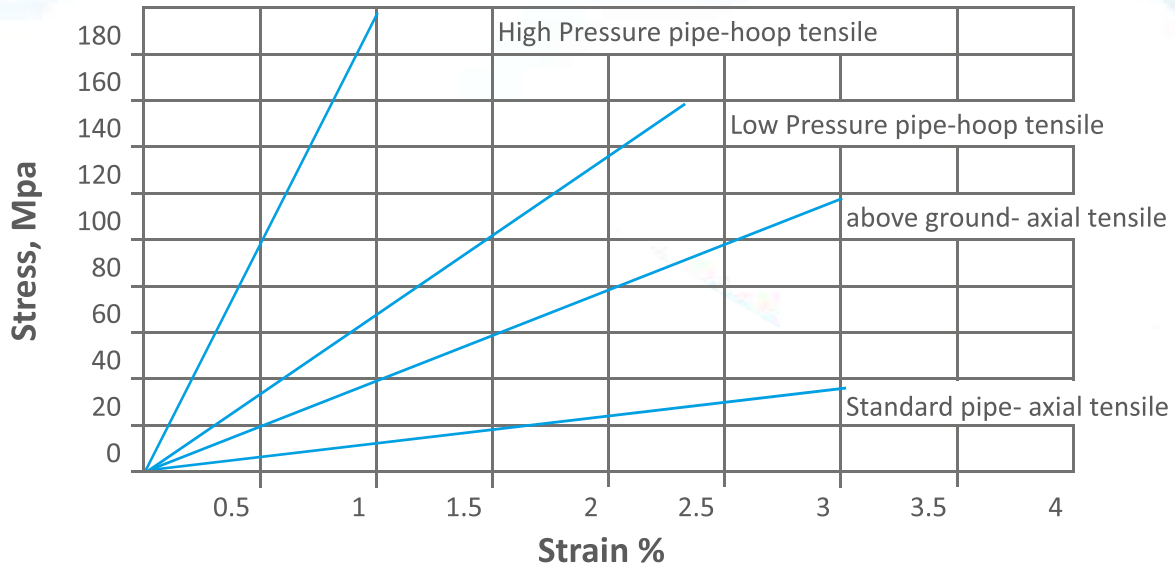

KPT Pneumato pipes and fitting coefficient of thermal expansion

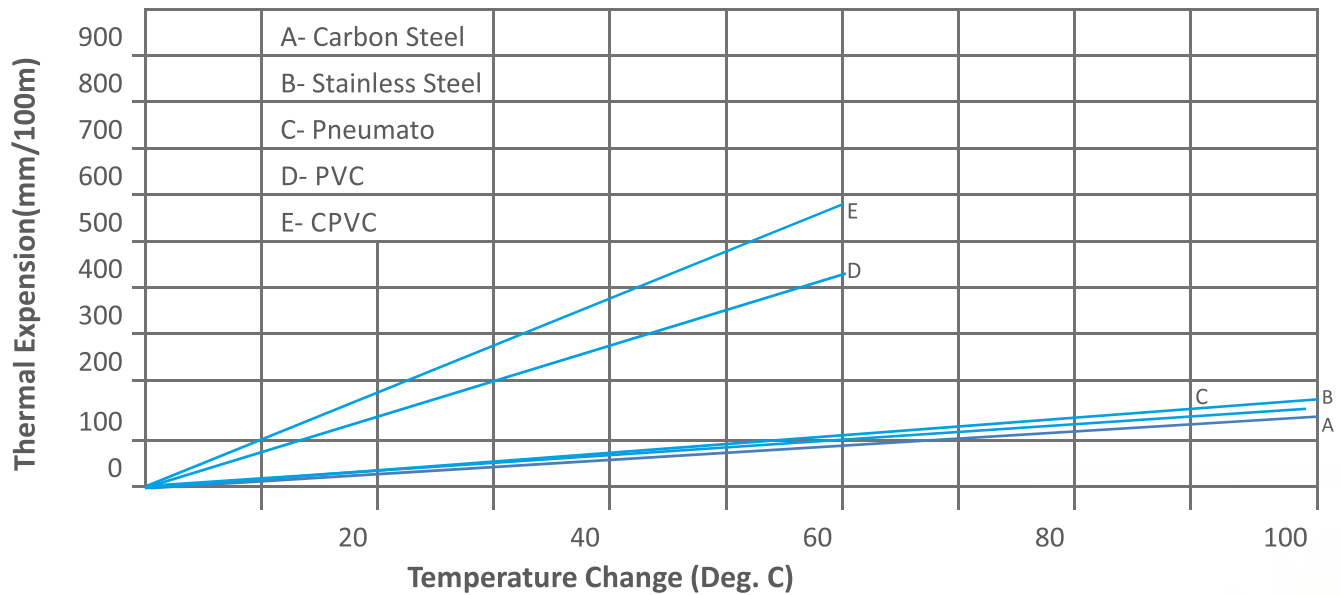

THERMAPLUS THERMAL FR+V0 COMPOSITE PIPES & FITTINGS (FLAME RETARDANT)

Mono & Triple layer | Flame Retardant | PN 10, PN 16 & PN 20



potable water application



application in the field ship building



connection heating and cooling



district heating pipeline systems



swimming-pool technology



chilled water technology



chemical transport



ceiling heating and cooling



Thermal FR+V0 Composite Piping (Flame Retardant)

A brand new from the house of KPT, we proudly introduce KPT Thermaplus pipes and fittings plumbing system for firefighting lines various other applications. The outer and middle layer of the pipes is being made of flame retardant material which can easily with stand flames for ensuring safe passage for the public at large and excellent performance with long life in direct sunlight having UV resistant on the upper layer. The middle layer glass fiber reinforced with in the two layer of PPRC act as an agent to reduce extension capability and produce durability to high pressure at high temperature. This plumbing system is ideal for all kinds of firefighting lines, Hotels, Malls, Industries, Schools, Residential Apartments etc.

KPT Thermaplus piping is preferably advisable to use in highly corrosive chemicals, higher and lower temperature applications as well as all types of process and utility applications, soft water, raw water, R.O water, D. M water etc. KPT brand Thermaplus Pipes and Thermal Fittings are having lot of advantages which can overcome the issues like leakages, pressure drop and corrosion – erosion in Metal Piping. Those are as under:

- **Leak proof Joining System:**

Thermaplus pipe and fittings provides leak proof joining throughout the life of pipes and fittings, because the joining system used in Thermaplus pipe and fittings is socket fusion welding where the outer diameter of the pipe and the inner diameter of fitting are heated and the joint is made. And there are two main advantages of this joining system, firstly the leak proof joining is created and secondly there is no ring created in the pipe which prevents scaling in the piping, wherein metal pipe; there is a threaded type of joint which creates leakages and increases the chances of scaling in the pipe. And in case of any plastic pipe; the joining system used is the Butt Welding where there is a ring created inside the pipe which will act like a barrier to any fluid or chemical which passes in the pipes and it also causes scaling in the pipes.

- **Non Corrosive & Rust Free Pipe:**

Thermaplus pipe and fittings is a non-metallic technology for industrial application. Generally industries use traditional metal piping system where they face huge problem of corrosion and rust as there was no other option which was later a cause for creation of leakage in the piping system but with Thermaplus pipe and fittings; you can have rust and leak proof piping.

- **NO Temperature loss and Minimum insulation:**

One of the major problems faced by any industrial user is the temperature loss. Many applications in which it becomes necessary to maintain the temperature; companies face problem of temperature loss and sweating from the piping in metal and any plastic pipes and that forces them to have a thick insulation which is very expensive and also maintenance leading. But with Sandwich Glass Fiber Technology in Thermaplus pipe and fittings; there is no temperature loss, as the thermal conductivity in Thermaplus pipe and fittings is 0.024 Btu/hr ft°F, which is 1700 times lesser compare to metal pipes and 11 times lesser compared to any plastic pipes. So the middle GLASS FIBER layer acts as insulation to the pipe. Hence, it requires minimum insulation.

- **Smoother iner surface with better flow & no scope of scaling:**

The roughness is calculated in terms of the RA Value and the RA Value of Thermaplus pipe and fittings is 0.07 Micron which is very much lesser compared to any metal pipes. And with higher RA Value there is more friction in the piping and hence in any metal piping there is lot of friction which affects the flow in the piping and it also creates scaling but Thermaplus pipe and fittings have smoother inner surface so there is no chance of friction and it gives very easy and smooth flow in the piping. Moreover there is no possibility of scaling in our piping.

Comparison of Thermaplus piping and Aluminium / Metal Piping

Criteria	Thermaplus Pipes	Aluminium/Metal Pipes
Thermal Conductivity	Lowest Thermal Conductivity 0.013 Btu/hr leading to Negligible Heat Loss	Higher Thermal Conductivity 27.09 Btu/hr leading to higher Heat Loss
Friction Loss related to RA Value	Least RA Value i.e. 0.1 Micron prevent Friction Loss in the pipeline	0.7 Micron RA Value leads to higher Friction Loss in the pipeline
Insulation	Sandwich Glass Fiber Reinforcement layer increases the temperature withstand capacity; in turn requires lesser insulation to prevent sweating	Owing to aluminium material, requires very thick insulation to prevent sweating and heat loss
Joining System	Socket fusion joining system assuring 0% leakage	100% chances of leakages due to push fit joints depending on O-rings
C Value Related to high flow	150C Value gives higher and smoother fiber reducing the energy consumption	130C Value depending on O-rings consumers more energy
Pressure holding test	Glass Fiber Reinforcement composition with thermaplus pipe and fittings is successful in pressure holding test	Push fit joints depending on O-rings fails in pressure holding test
Energy saving	Energy saving due to 0% leakages	Higher energy consumption due to friction loss and leakage
Maintenance	NIL Maintenance having benefits such as Least Thermal Expansion and Sagging	High chances of Maintenance because of higher Thermal Expansion leading to sagging as well as Insulation

Thermaplus Brand of K.P.T. Thermal FR+V0 Composite pipe

1. Absolutely Flame Retardant V2 Grade Pipes & fitting.
2. Almost double strength owing to Glass Fiber Reinforcement Technology.
3. Higher temperature resistance owing to inbuilt Glass Fiber Reinforcement layer.
4. Very less Thermal Expansion because of Sandwich Glass Fiber Reinforcement Layer.
5. 50% less clamping requirement compared to PPR Pipes due to Glass Fiber Reinforcement Layer.
6. NIL Maintenance having benefits such as Least Thermal Expansion and Sagging.
7. Owing to Sandwich Glass Fiber Reinforcement layer, very less sagging gives nice and Aesthetic View to the pipeline
8. Negligible Friction loss owing to higher C Value – 150 and Least RA Value – 0.1 Micron
9. Socket Fusion joining system guaranteeing 100% Leak Proof element in pipes.
10. No obstruction creation inside pipeline which leads to least Pressure Drop.
11. 100% Non Corrosive product provides absolutely Corrosion Free piping which does not create any leakage.
12. Up to 5% energy saving owing to least RA Value, higher C Value and 100% leak proof element
13. Higher flow rate 25% (bigger ID)
14. Energy saving 25%
15. Thermaplus pipes reduce passive heat loss by around 20% for non-insulated pipe.
16. Chemicals and acid applications
17. 4X lower linear thermal expansion

RANGE AVAILABLE IN PN 10, PN16 & PN 20

Technical Data of KPT Thermaplus Pipes:

S.No.	PROPERTY	UNIT	KPT (PP-GF) PIPE
1	Thermal Conductivity	Btu/hrs	0.013
2	Coefficient Linear Thermal Expansion		1.0X10 ⁻⁴
3	Flexural Modulus	Mpa	1300
4	Tensile Strength at break	Mpa	48
5	Melting Temperature Rate	°C	160-165
6	Vicat Softening Temperature	°C	147.5

Applications

1. Firefighting lines
2. Chemical and acid Plants
3. Cooling and chilled water
4. Hydraulic Oil (Pressure 20kgf)
5. Geo thermal application
6. Recycle water
7. Air conditioning
8. Potable water hot and cold
9. Solar Heaters application
10. Liquid foods
11. Watering system for greenhouse and gardens
12. Transportation aggressive fluids
13. Water purifying plants
14. Radiator heating
15. Traditional heating system
16. Air distribution and compressed air system

PRODUCT INSTALLATION

- Chemical Industries
- Chilled Water Piping
- Pneumatic Air applications





- Water transportation
- Solar water heaters
- Compressed Air applications
- Cooling tower applications



PRODUCT INSTALLATION





SOME OF OUR PRESTIGIOUS CLIENTS



AN ISO 9001:2015 & ISO 14001:2015 CERTIFIED COMPANY

OUR CERTIFICATIONS

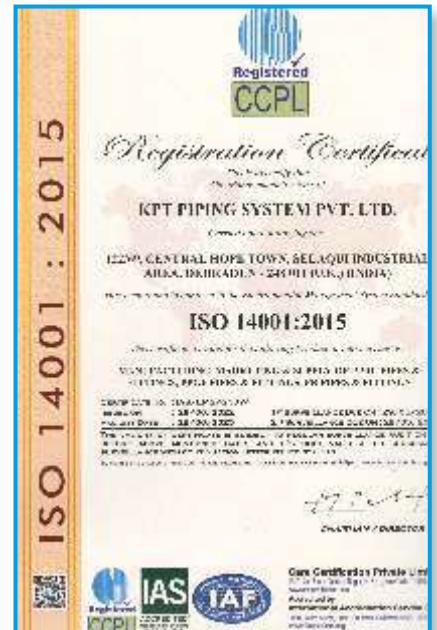
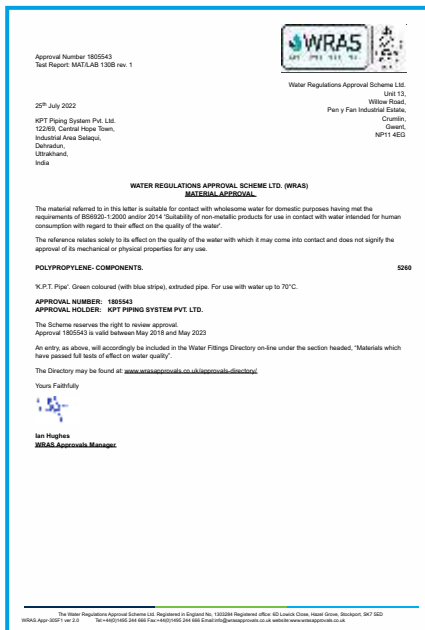

**ONLY COMPANY
IN ASIA TO MAKE
PPR-C PIPES AND FITTINGS
IN 5 DIFFERENT COLORS
FOR MULTIPLE APPLICATIONS**

**MONO AND TRIPLE LAYER
GREEN, BLUE, WHITE
GREY & RED COLOUR**



AN ISO 9001:2015 & ISO 14001:2015
CERTIFIED COMPANY

KPT PIPING SYSTEM PRIVATE LIMITED

Regd. Office: Unit no. 305-306, P.P. Trade Center, Plot no. P-1, Netaji Subhash Place,
New Delhi-110034 India

Works: 122/69, Central Hope Town, Selaqui, Industrial Area,
Dehradun-248197 (Uttarakhand)

Ph.: +11-45360050, + 91 8178402742, + 91 9354940961

Email: info@kptpipes.com | Web: www.kptpipes.com



Toll Free No.: 1800-270-4672